

installation guide

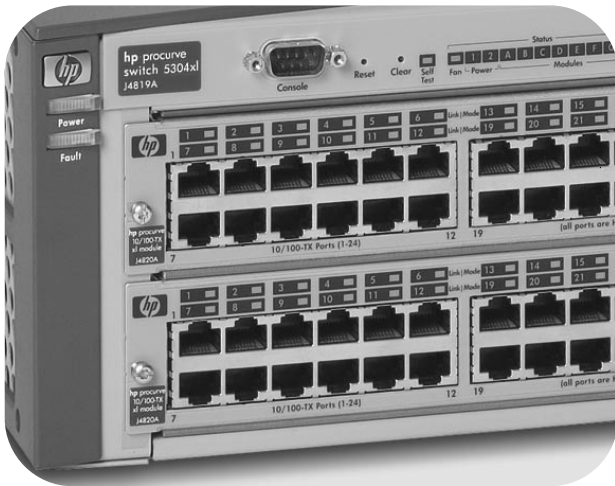

hp procurve switch
xl modules

www.hp.com/go/hpprocurve

HP Procurve Switch XL Modules

Installation Guide

**© Copyright 2001, 2002 Hewlett-Packard Company
All Rights Reserved**

Reproduction, adaptation, or translation without prior written permission is prohibited, except as allowed under the copyright laws.

Publication Number

5990-3019
April 2002

Applicable Products

HP Procurve Switch 10/100-TX XL Module (J4820A)
HP Procurve Switch 100/1000-T XL Module (J4821A)
HP Procurve Switch mini-GBIC XL Module (J4878A)

Disclaimer

The information contained in this document is subject to change without notice.

HEWLETT-PACKARD COMPANY MAKES NO WARRANTY OF ANY KIND WITH REGARD TO THIS MATERIAL, INCLUDING, BUT NOT LIMITED TO, THE IMPLIED WARRANTIES OF MERCHANTABILITY AND FITNESS FOR A PARTICULAR PURPOSE. Hewlett-Packard shall not be liable for errors contained herein or for incidental or consequential damages in connection with the furnishing, performance, or use of this material.

Hewlett-Packard assumes no responsibility for the use or reliability of its software on equipment that is not furnished by Hewlett-Packard.

Warranty

See the Customer Support/Warranty booklet included with the product.

A copy of the specific warranty terms applicable to your Hewlett-Packard product and replacement parts can be obtained from your HP sales and service office or HP-authorized reseller.

Contents

HP Procurve Switch XL Modules Installation Guide

Descriptions	1
Features	2
Installing the Modules	4
Overview	4
Installing the Module in an Unused Slot	5
Installing or Removing the mini-GBICs	7
Verifying the Module is Installed Correctly	8
Connecting the Network Cables	9
Verifying the Network Connections Are Working	11
Customizing the Port Configuration	12
Replacing or Removing a Module	13
Resetting the Switch	14
Reasons for Resetting the Switch	14
Methods of Resetting the Switch	14
Troubleshooting	15
Switch and Module LED Error Indicators:	15
Diagnostic Tips:	15
Customer Support Services	19
Specifications	19
Environmental	19
Lasers	19
Connectors	20
Cables	20
Mode Conditioning Patch Cord for Gigabit-LX	22
Installing the Patch Cord	23
Recommended Patch Cords	23
EMC Regulatory Statements	24

HP Procurve Switch XL Modules

For the HP Procurve Series 5300XL Switches

Descriptions

The HP Procurve Switch XL Modules are components that you can add to an HP Procurve XL switch to provide a variety of network connectivity options.

The following modules are available as of this printing:

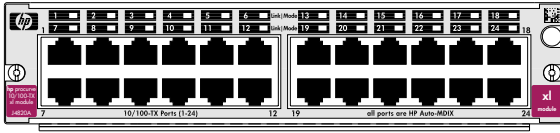
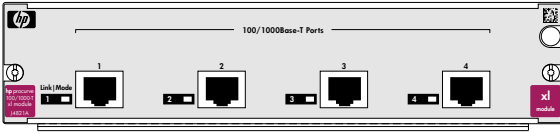
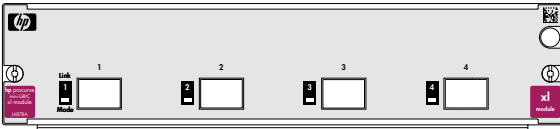
Module	Description
<p>HP Procurve Switch 10/100-TX XL Module (J4820A)</p> 	<p>24 twisted-pair ports with RJ-45 connectors for 10 Mbps or 100 Mbps operation over 100-ohm unshielded (UTP) or shielded (STP) twisted-pair cable -- all ports have the HP Auto-MDIX feature.</p>
<p>HP Procurve Switch 100/1000-T XL Module (J4821A)</p> 	<p>4 twisted-pair ports with RJ-45 connectors for 1000 Mbps (Gigabit) or 100 Mbps operation over Category 5 or better 100-ohm UTP or STP cable (<i>category 5E recommended for Gigabit</i>) -- all ports have the IEEE 802.3ab Auto MDI/MDI-X feature.</p>
<p>HP Procurve Switch mini-GBIC XL Module (J4878A)</p> 	<p>4 slots for installing any of the supported HP Procurve mini-GBICs*.</p>

* **Supported mini-GBICs:** The following HP Procurve mini-GBICs are supported by the mini-GBIC XL Module (as of this printing):

- Gigabit-SX LC mini-GBIC (J4858A)
- Gigabit-LX LC mini-GBIC (J4859A)

Contact your HP-authorized networking products reseller or your HP representative for information on availability of other modules and mini-GBICs. You can also visit the HP networking products Web site at <http://www.hp.com/go/hpprocurve> to get more information.

Features

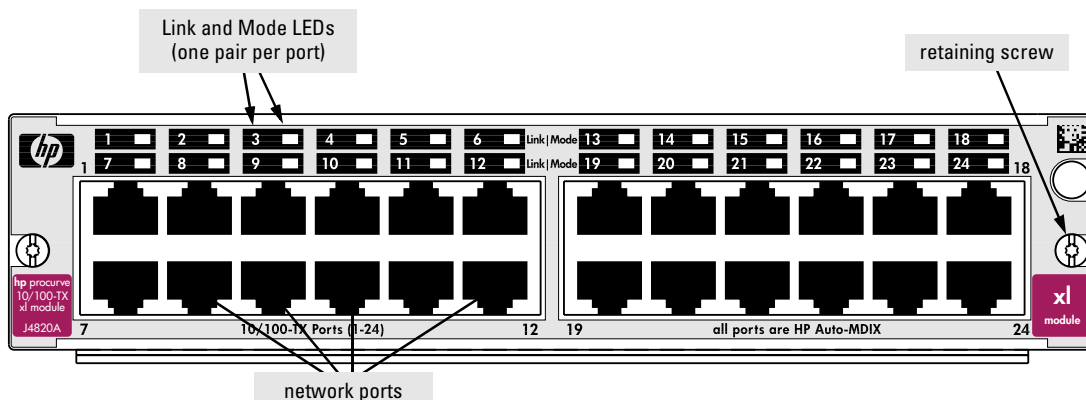

Example: The HP Procurve 24-Port 10/100-TX XL Module

The HP Procurve Switch XL Modules have the following features:

- auto-enabled ports—the ports are all configured to be ready for network operation as soon as a viable network cable is connected
- auto-configuration—a default configuration is applied to the module when the switch is powered on and the module passes self test; this default configuration works well for most network installations
- LEDs that provide information for each port on the link status, network activity, connection bandwidth (speed), communication mode (half or full duplex), and presence of specific network error packets on the port
- “hot swap modules” operation—you can add a module or replace a module without having to shut down the switch (changing the module type in a given slot *does* require a switch reset)
- “hot swap mini-GBICs” operation—you can add, replace, or change the type of any of the mini-GBICs that you use in the mini-GBIC XL Module, without having to first remove the module, and without having to shut down the switch

- the ports on the 10/100-TX XL Module have the **HP Auto-MDIX** feature, and the ports on the 100/1000-T XL Module have the IEEE 802.3ab **Auto MDI/MDI-X** feature. These features operate the same way and allow you to use either “straight-through” or “crossover” twisted-pair cables for all the twisted-pair network connections. Please see the note on “Automatic Cable Sensing” on page 10.
- standards adherence:
 - the 10/100-TX XL Module is compatible with the IEEE 802.3 10Base-T and IEEE 802.3u 100Base-TX standards
 - the 100/1000-T XL Module is compatible with the IEEE 802.3ab 1000Base-T and IEEE 802.3u 100Base-TX standards
 - the ports on the SX and LX mini-GBICs that are installed in the mini-GBIC XL Module are compatible with the IEEE 802.3z Gigabit-SX and Gigabit-LX standards respectively.

Installing the Modules

Overview

You can install any of the modules into any of the HP Procurve XL Switches that have a compatible module slot. As of this printing, those are the HP Procurve Series 5300XL Switches:

- 5308XL (p/n J4819A)
- 5372XL (p/n J4848A)
- 5348XL (p/n J4849A)
- 5304XL (p/n J4850A)

You can install the modules into the switch either with the switch powered on or off. The following procedures assume the switch is powered on.

1. Install the modules in a switch slot (see page 5).

If you have installed any modules into slots that were previously occupied by a different type module, you need to now reset the switch (see page 14).

2. If you are using the mini-GBIC XL Module, install the mini-GBICs in the module. You can install the mini-GBICs before or after installing that module into the switch (see page 7).

Note

The mini-GBICs can be “hot swapped”. That is, they can be installed or removed after the mini-GBIC XL Module is installed in the switch and the module is receiving power. For more information, see page 7.

3. Verify that the modules are installed correctly (see page 8).
4. Connect the network cabling (see page 9).
5. Verify that the network connections are working properly (see page 11).
6. Optionally, customize the configuration for the modules’ ports (unless the default port configuration is satisfactory for your network application - see page 12).

Note

If necessary, you can “hot-swap” one module for another; that is, replace one module with another while the switch is still powered on, without interrupting the operation of the rest of the switch ports. For more information, see page 13.

Installing the Module in an Unused Slot

Installation Precautions:

- Static electricity can severely damage the electronic components on the modules. When handling and installing the modules in your switch, follow these procedures to avoid damage from static electricity:
 - Handle the module by its bulkhead or edges and avoid touching the components and the circuitry on the board.
 - When installing the module, equalize any static charge difference between your body and the switch by wearing a grounding wrist strap and attaching it to the switch's metal body, or by frequently touching the switch's metal body.
- ***The HP Procurve Switch XL Modules have “low-force”, high-performance connectors. High insertion forces are not necessary to install the modules, and should not be used.***
- ***Make sure that you fully insert the modules.*** That is, press the module into the slot until the bulkhead on the module is contacting or is very close to contacting the front face of the switch chassis.
- Once the module is fully inserted, make sure that you screw in the two retaining screws to secure the module in place.
- For safe operation, proper switch cooling, and reduction of electromagnetic emissions, ensure that a slot cover is installed on any unused module slot. *For safety, no more than one slot should be uncovered at a time when the switch is powered on.*

Installation Procedures:

1. Use a Torx T-10 or flat-bladed screwdriver to unscrew the screws in the cover plate over the slot you want to use, and remove the cover. Store the cover plate for possible future use.
2. Hold the module by its bulkhead—taking care not to touch the metal connectors or components on the board.
3. As shown in the illustrations on the next page, insert the module into the slot guides and slide it into the slot until it stops. Then press near the two screws on the module bulkhead to seat the module connector into the switch backplane. The module bulkhead should be in contact with or very close to contact with the back face of the switch.

Note: The HP Procurve Switch XL Modules have “low-force”, high-performance connectors. High insertion forces are not necessary to install the modules and should not be used.

HP Procurve Switch XL Modules

Installing the Modules

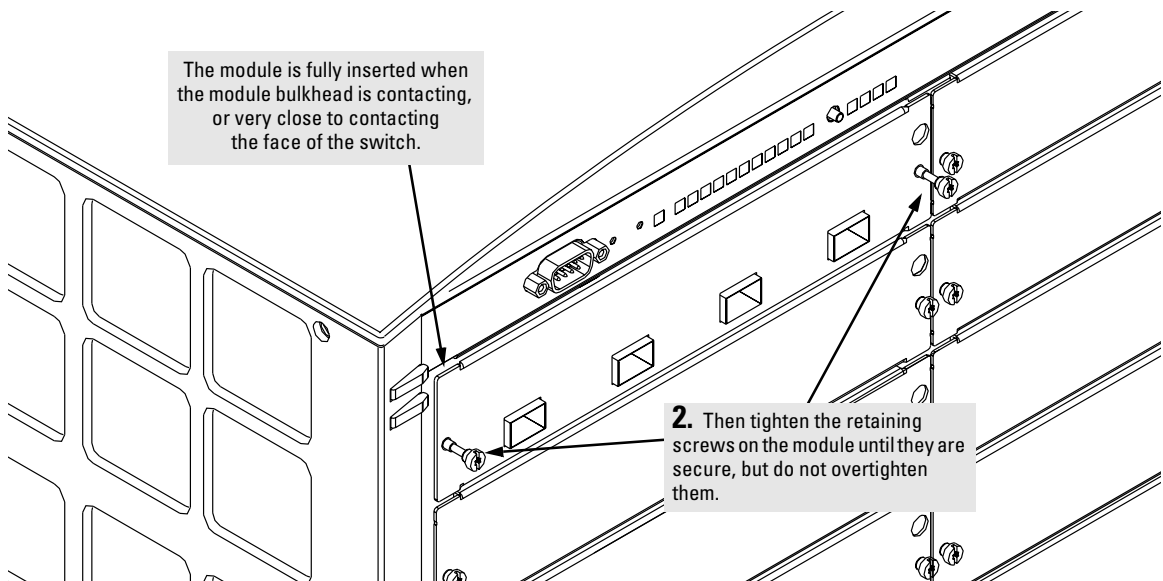
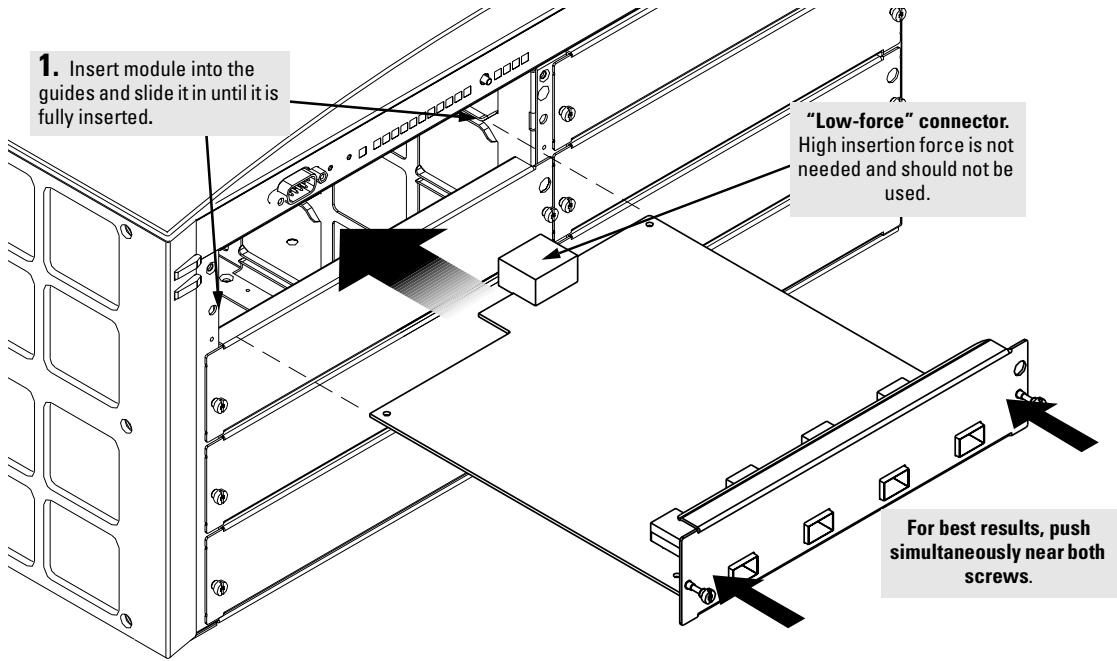

Installing or Removing the mini-GBICs

You can install or remove the mini-GBIC from the mini-GBIC XL Module without having to power off the switch. Use only HP Procurve mini-GBICs.

Caution

The HP Procurve mini-GBICs are Class 1 laser devices. Avoid direct eye exposure to the beam coming from the transmit port.

Installing the mini-GBICs:

Hold the mini-GBIC by its sides and gently insert it into any of the slots in the module until the mini-GBIC clicks into place.

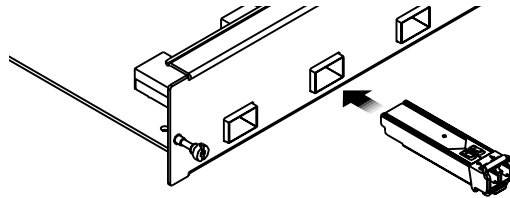

Removing the mini-GBICs:

You should disconnect the network cable from the mini-GBIC before removing it from the module.

Depending on when you purchased your HP Procurve mini-GBICs, it may have either of two different release mechanisms: a plastic tab on the bottom of the mini-GBIC, and a wire bail.

To remove the mini-GBICs that have the plastic tab, push in the plastic tab until you see the mini-GBIC release from the switch (you can see it move outward slightly), and then pull it from the slot.

To remove the mini-GBICs that have the wire bail, lower the bail until it is approximately horizontal, and then using the bail, pull the mini-GBIC from the slot.

Verifying the Module is Installed Correctly

Observe the Module Status LED for the slot in which the module is being installed, and the Self Test and Fault LEDs on the switch to verify that the module is installed properly.

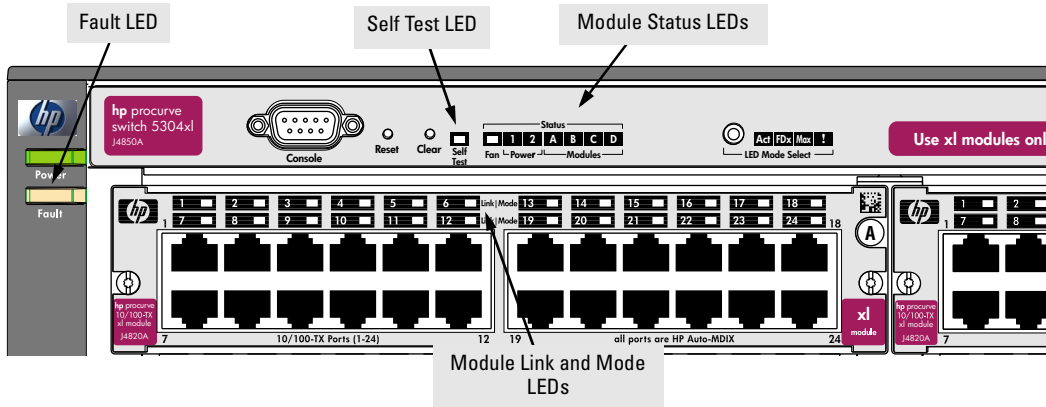

When the module is installed properly and the switch is powered on, or the module is installed when the switch already has power, the module undergoes a self test that takes a few seconds. You can use the LEDs to determine that the module is installed properly and has passed the self test, as described in the “LED Behavior” table below.

LED Behavior

LED	Display for a Properly Installed Module
Module Status	(for the slot in which you are installing the module) The LED goes ON as soon as the module is installed and the switch is powered on, and stays ON steadily.
Self Test	ON briefly while the module is being tested, then OFF. Note: If the switch was powered off while the module was installed, when the switch is powered on, the Self Test LED will stay ON for the duration of the whole switch self test.
Fault	OFF
Link and Mode (on the modules)	For a module that is installed when the switch is already powered on (hotswap), all the Link and Mode LEDs on the module go ON for approximately 3 to 10 seconds, then OFF for 5 to 10 seconds depending on the module. Then, the Self Test LED on the switch goes OFF. If the module is already installed when the switch is powered on or reset, the process described above occurs approximately 30 seconds after the power on or reset, during which the switch is being tested.

Connecting the Network Cables

Connect the appropriate network cables to the module's ports as shown in the table below. The table shows the supported cable types for the 10/100-TX XL Module and the 100/1000-T XL Module, and for the SX and LX mini-GBICs that are installed in the mini-GBIC XL Module. For more information on the cable specifications, see “Cables” on page 20.

Supported Cable Types

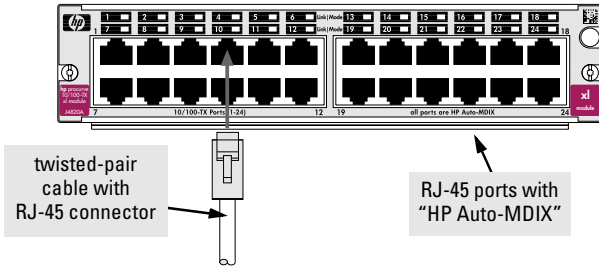
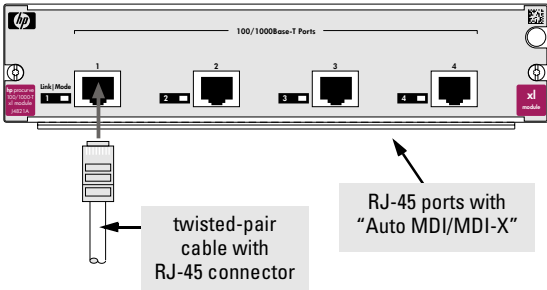
Module	Cable Type	Maximum Length
10/100-TX XL Module 	10 Mbps operation: category 3, 4, or 5, 100-ohm differential twisted-pair cable 100 Mbps operation: category 5, 100-ohm differential twisted- pair cable	100 meters (recommended) 100 meters
100/1000-T XL Module 	100 Mbps operation: category 5, 100-ohm differential twisted- pair cable 1000 Mbps (Gigabit) operation: category 5E, 100-ohm cable is recommended, although category 5 cable may also work.	100 meters 100 meters

Notes:

- The RJ-45 ports on this module have the HP Auto-MDIX feature. In the module's default configuration, Auto, **either a straight-through or crossover cable can be used** to connect the module to any other 100Base-TX or 10Base-T device. See the Note on page 10.
- Since the 10Base-T operation is through the 10/100Base-TX ports, if you ever want to upgrade the ports to 100Base-TX, it would be best to cable the ports initially with category 5 cable.

Note: In the module's default configuration, Auto, **either a straight-through or crossover cable can be used** to connect the module to either another Gigabit device or to a 100Base-T device. See the Note on page 10.

HP Procurve Switch XL Modules

Installing the Modules

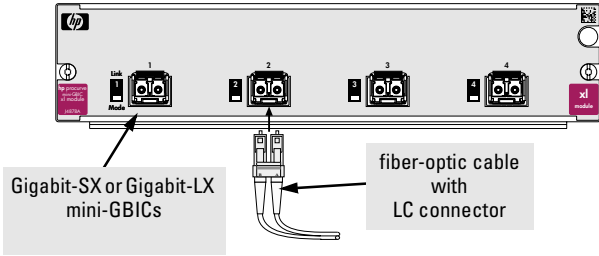
Module	Cable Type	Maximum Length
<p>mini-GBIC XL Module</p> 	<p>Gigabit-SX operation: multimode fiber-optic cables fitted with LC connectors</p> <p>Gigabit-LX operation: single-mode fiber-optic cables fitted with LC connectors. multimode fiber-optic cables may also be used—see “Fiber-Optic Cables” on page 21.</p>	<p>220 meters to 550 meters, depending on the cable used. See “Fiber-Optic Cables” on page 21 for more information.</p> <ul style="list-style-type: none"> • single-mode cable: 10 kilometers • multimode cable: 550 meters

Note

Automatic Twisted-Pair Cable Sensing:

When the ports for the 10/100-TX XL Module and the 100/1000-T XL Module are in their default configuration, Auto, both modules automatically negotiate whether the ports operate as MDI or MDI-X, depending on the cable type and the connected device’s operation. As a result, you can use either “straight-through” or “crossover” twisted-pair cable for all network connections to these modules.

On the 10/100-TX XL Module, this feature is identified as **HP Auto-MDIX**; on the 100/1000-T XL Module, it is identified as **Auto MDI/MDI-X** and it is part of the IEEE 802.3ab standard. Both features operate the same.

Operation of these feature depends on the port configurations being kept at Auto. If the configuration is changed to one of the available fixed options though (for example, 100-Full Duplex), the port operates as an MDI-X port. In that case, to connect the module to another switch or hub, use a crossover cable; to connect to an end node, use a straight-through cable.

Verifying the Network Connections Are Working

Check the port LEDs for the newly-installed module to ensure that the port(s) connected in the preceding step are operating correctly. Each port on the switch modules has Link and Mode LEDs near it as shown in the next illustration.

Example Link and Mode LEDs

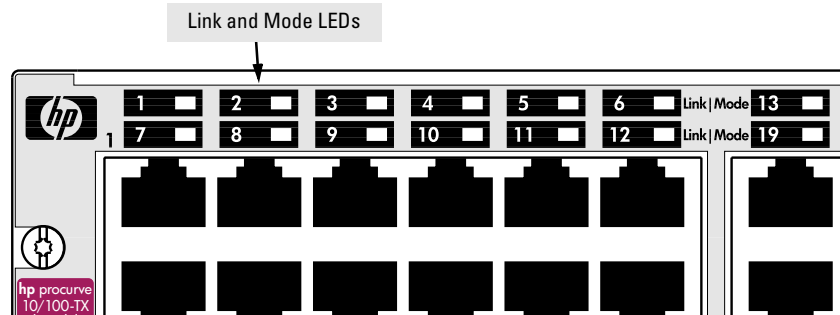

- The Link LED will be lit for each port that is connected properly to an active network device.

If the Link LED does not go on when an active network cable is connected to the port, there may be something wrong with the cable, the cable connectors, or the device at the other end of the cable. See the troubleshooting information on page 15.
- If the switch Mode is set to display activity (the **Act** mode indicator LED is lit), then the Mode LED for each port that is transmitting and/or receiving packets will flicker when traffic is detected on the port.
- If the Mode is set to display full duplex (the **FDx** mode indicator LED is lit), then the Mode LED will be lit for each port that is operating in full duplex.
- If the Mode is set to display maximum link speed operation (the **Max** mode indicator LED is lit), then the Mode LED will be lit for each port that is operating at its maximum possible link speed. *For gigabit-capable ports, that speed would be 1000 Mbps (Gigabit); for 10/100 ports, that speed would be 100 Mbps.*
- If the Mode is set to display packet errors on the port (the **!** mode indicator LED is lit), then the Mode LED will flash briefly for each packet that has any of six errors, including CRC errors and late collisions.

Customizing the Port Configuration

If the slot in which you installed the module was empty the last time the switch was either rebooted or reset (or the power to the switch was cycled), then the module will use preconfigured default parameter values that will work for most networks.

The default port configurations for connection parameters are:

- **Ports Enabled:** Yes
- **Mode:**
 - **10/100-TX XL Module:** Auto — The port auto negotiates speed (10 or 100 Mbps), communication mode (half or full duplex), and MDI or MDI-X port operation. *Note: if you configure the port to one of the fixed 100 Mbps modes, the port will then operate only as an MDI-X port.*
 - **100/1000-T XL Module:** Auto — The port auto negotiates speed (1000 or 100 Mbps), communication mode (half or full duplex), and MDI or MDI-X port operation. *Note: if you configure the port to one of the fixed 100 Mbps modes, the port will then operate only as an MDI-X port.*
 - **Gigabit-SX and Gigabit-LX ports in mini-GBIC XL Module:** Auto — The port always operates at 1000 Mbps and auto negotiates communication mode (half or full duplex).
- **Flow Control:** Disabled
- **Advanced features** — Spanning Tree, Trunking, Meshing, VLANs, IGMP, LACP, Routing, Class of Service, Security, etc.: all Disabled

If necessary, configure the port(s) in the module by using the switch console or the web browser interface. For more information, see the *Management and Configuration Guide* shipped on the documentation CD that came with the switch, and the online Help provided in the console and web browser interface.

If the default port configuration listed above is acceptable for your network, then skip this process.

Replacing or Removing a Module

Follow these procedures to replace one module with another, or to remove a module without replacing it:

1. Remove any network cables from the ports on the module.
2. On the module you want to remove from the switch, unscrew the retaining screws enough to disconnect them from the threaded holes in the switch.

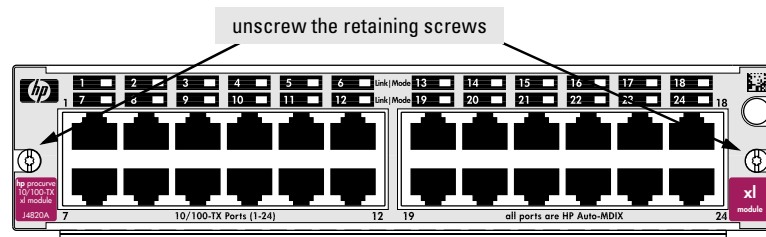

3. Grab the screws and pull the module out from the slot. It may help to brace your hands against the face of the switch and “lever” the module out from the switch slot.
4. Do one of the following:
 - If you will be installing another module in the slot, go to “Installing the Module in an Unused Slot” on page 5 and begin with step 2.
 - If you will not install another module in the slot (that is, leave it empty), then re-install a slot cover plate over the empty slot opening.

Caution

For proper cooling and reduction of electromagnetic emissions, ensure that a slot cover is installed on any unused slot.

5. Reset the switch, as described under “Resetting the Switch” on page 14, if you are exchanging one type of module with a different type of module in the same slot (for example, replacing a 10/100-TX XL Module with a 100/1000-T XL Module).

If you are replacing a module with another one of the *same* type in the same slot, it is not necessary to reset the switch. The current configuration for ports in that slot will apply to the new module.

Resetting the Switch

Reasons for Resetting the Switch

Generally, you only need to reset the switch when it needs to recognize a change in its hardware or software (console) configuration. Some circumstances in which you will need to reset the switch are:

- Installing a module in a slot that was previously occupied by a different type of module—for example, installing a 100/1000-T XL Module in a slot that was previously used for a 10/100-TX XL Module—the switch must be reset after the new module is installed so the switch processor can properly initialize and configure the new module type.

Note

When a module is exchanged for a different type, until the switch is reset the module will not operate, the Module Status LED for the slot will continue to flash, and all the LEDs on the module will stay on continuously.

- Changing certain switch configuration parameters through the console interface. (In this case, the console provides indications when the switch must be reset for the configuration change to be activated.)

You do not need to reset the switch when:

- Installing a module in a previously unused slot.
- Replacing a module with the *same* type of module.

Methods of Resetting the Switch

You can reset the switch by any of these methods:

- pressing the Reset button on the front of the switch
- power cycling the switch (if both power supplies are being used, you will have to disconnect both power cords)
- issuing the **reboot system** command from the switch console CLI, or selecting the Reset or Reboot option from the switch console menu, web browser interface, or HP TopTools for Hubs & Switches

Troubleshooting

One of the primary tools for troubleshooting the switch modules are the LEDs on the front of the switch and on the modules. Refer to “LED Behavior” on page 8 for a description of the normal LED behavior. Also, refer to the switch *Installation and Getting Started Guide* for more detailed troubleshooting information for the switch.

The following tables describe switch and module LED displays that indicate that the module or connections to the ports on the module are not operating correctly.

Switch and Module LED Error Indicators:

Fault	Self Test	Module Status	Port Link	Diagnostic Tips
Flashing [†]	Flashing [†]	Flashing [†]	Never On	❶
Flashing [†]	Flashing [†]	Flashing [†]	On briefly, then Off	❷
Off	Off	Flashing [†]	Off	❸
Flashing [†]	Flashing [†]	Flashing [†]	Flashing [†]	❹
Off	Off	Off	Fast Flashing ^{††}	❺
Off	Off	On	Off with cable connected	❻

[†] The flashing behavior is an on/off cycle once every 1.6 seconds, approximately.

^{††} The fast flashing behavior is an on/off cycle once every 0.8 seconds, approximately.

Diagnostic Tips:

See the tables on the next three pages to diagnose the LED error indicators in the previous table.

Tip Number	Problem	Solution
1	The module installed in the slot that corresponds to the letter that is flashing is an invalid module.	<p>The fact that the Link and Mode LEDs never are lit on the module indicates that it is a Procurve Switch GL module and should not be used in your XL switch.</p>  <p>Make sure that you have installed an XL module in the slot. HP Procurve GL modules will fit in the slot, but they are not compatible with your Procurve XL switch. Check to make sure that the module has a magenta “xl module” symbol on it.</p> <p>Remove the module from the switch and replace it with an XL module, or recover the slot with the cover plate. You can remove and replace the module without having to power down the switch. Call your HP-authorized LAN dealer, or use the electronic support services from HP to get information on supported Switch XL modules.</p>
2	The module installed in the slot that corresponds to the letter that is flashing has experienced a self test or initialization fault.	<p>The modules are all tested whenever the switch is powered on, or reset (through the Reset button on the switch, or the Reboot or Reset options in the console or web browser interface), and when they are hot swapped (installed when the switch is powered on).</p> <p>Since the Link and Mode LEDs on the module were lit at least briefly, that indicates that the module did receive power from the switch, but the subsequent download process failed. The module may be faulty.</p> <p>Try removing and reinstalling the module. You can do this without having to power down the switch. When the module is reinstalled, it will be retested automatically.</p> <p>If the fault indication reoccurs, the module is faulty. Remove the module from the switch and replace it with another module, or recover the slot with the cover plate. Call your HP-authorized LAN dealer, or use the electronic support services from HP to get assistance. See the Customer Support/Warranty card for more information.</p>
3	A module was installed in the slot that is a different type than the previously installed module, and the switch has not yet been reset.	<p>When you “hot swap” modules in the switch slot, if you install a different module type than the one that was previously installed in the slot, you must reset the switch so the switch processor can properly initialize and configure the new module type. The flashing LED informs you that this change of module types has occurred. The module will not work properly until the switch is reset as indicated by all the module’s LEDs staying on until the switch is reset.</p> <p>See “Resetting the Switch” on page 14.</p>

Tip Number	Problem	Solution
4	<p>The network port for which the Link LED is flashing has experienced a self test or initialization failure.</p>	<p>During the module self test (described in item 1 above), each network port is also tested. If the port self test fails, the individual port is not usable, but the rest of the ports on the module, which have passed their self test, will continue to operate normally.</p> <p>If the error has occurred on a mini-GBIC that you have installed in the mini-GBIC XL Module, make sure that it is one of the supported mini-GBICs. The HP Procurve mini-GBICs that are supported, as of the printing of this manual, are listed on page 1. Use only the supported HP Procurve mini-GBICs. If it is a supported mini-GBIC, it may have failed. Try removing and reinstalling the mini-GBIC and it will be tested again. If the fault indication reoccurs, the mini-GBIC is faulty and must be replaced.</p> <p>If the error has occurred a port that is a known valid mini-GBIC or on a twisted-pair port on one of the other modules, try removing and reinstalling the module. If the port fault indication reoccurs, and you need to be able to use the port, you will have to replace the module. In the mean time, all the other module ports will operate normally.</p>
5	<p>The network port for which the Link LED is flashing has been disabled because port security has been configured on the switch and a security violation has been detected on the port.</p>	<p>For the Port Security feature, you can configure the switch so that whenever a security violation is detected on a port, the switch will disable the port. When a port is disabled by this feature, the port Link LED will be continuously flashed at the fast rate of 0.8 seconds per cycle. The flashing continues until you clear the security violation through the switch console. In the console, you can view the identity of the connected device that committed the security violation.</p> <p>Once the security violation is cleared, you must re-enable the port through the console.</p> <p>For more information on the Port Security feature, see the <i>Management and Configuration Guide</i> that is on the documentation CD-ROM that came with your switch.</p>

Tip Number	Problem	Solution
6	The network connection is not working properly.	<p>Try the following procedures:</p> <ul style="list-style-type: none"> • For the indicated port, verify that both ends of the cabling, at the switch and the connected device, are securely connected. • Verify the connected device and switch are both powered <i>on</i> and operating correctly. • Verify that you have used the correct cable type for the connection. See “Cables” on page 20 for the correct cable specifications. <ul style="list-style-type: none"> – for any of the twisted-pair connections, in the default configuration (Auto), either a “straight-through” or a “crossover” cable can be used and the switch will automatically adjust its operation. See the “Automatic Cable Sensing” description on page 10 for more information. <hr/> <p>Note: <i>If the module configuration is changed to one of the fixed configuration options though (for example, 100-Full Duplex), then the port operates as MDI-X only and the correct type of cable must be used. In general, for connecting to an end node (MDI port), use “straight-through” cable; for connecting to MDI-X ports on hubs or other switches, use “crossover” cable.</i></p> <hr/> – for fiber-optic connections, verify that the transmit port on the switch is connected to the receive port on the connected device, and the switch receive port is connected to the transmit port on the connected device. <ul style="list-style-type: none"> • For a 1000 Mbps connection, verify that the network cabling complies with the IEEE 802.3ab standard. The cable should be installed according to the ANSI/TIA/EIA-568-A-5 specifications. Cable testing should comply with the stated limitations for Attenuation, Near-End Crosstalk, Far-End Crosstalk, Equal-Level Far-End Crosstalk (ELFEXT), Multiple Disturber ELFEXT, and Return Loss. <p>The cable verification must include all patch cables from any end devices, including the switch, to any patch panels in the cabling path.</p> • Verify that the port has not been disabled through a switch configuration change. <p>You can use the console interface, or, if you have configured an IP address on the switch, use the web browser interface, or HP TopTools for Hubs & Switches network management software to determine the state of the port and re-enable the port if necessary.</p> • Verify that the switch port configuration matches the configuration of the connected device. For example, if the switch port is configured as “Auto”, the port on the connected device also MUST be configured as “Auto”. If the configurations don’t match, the results could be a very unreliable connection or no link at all. • If the other procedures don’t resolve the problem, try using a different port or a different cable.

Customer Support Services

If you are having any trouble with your module or switch, Hewlett-Packard offers support 24 hours a day, seven days a week through the use of a number of automated electronic services. See the Customer Support/Warranty booklet that came with your switch for information on how to use these services to get technical support. The HP networking products World Wide Web site, <http://www.hp.com/go/procurve> also provides up-to-date support information. Additionally, your HP-authorized network reseller can also provide you with assistance, both with services that they offer and with services offered by HP.

Specifications

Environmental

	Operating	Non-Operating
Temperature:	0°C to 40°C (32°F to 104°F)	-40°C to 70°C (-40°F to 158°F)
Relative humidity: (non-condensing)	15% to 95% at 40°C (104°F)	15% to 90% at 65°C (149°F)
Maximum altitude:	4.6 Km (15,000 ft)	4.6 Km (15,000 ft)

Lasers

The Gigabit-SX LC mini-GBIC, and the Gigabit-LX LC mini-GBIC, both of which can be installed in the mini-GBIC XL Module, are Class 1 Laser Products. Laser Klasse 1
These mini-GBICs comply with IEC 825-2: 1993.

Connectors

- The ports on the **10/100-TX XL Module** are compatible with the IEEE 802.3 10Base-T and 802.3u 100Base-TX standards and accept the 10 Mbps or 100 Mbps cables listed below.
- The ports on the **100/1000-T XL Module** are compatible with the IEEE 802.3u 100Base-TX and IEEE 802.3ab 1000Base-T standards, and accept the 100 Mbps or 1000 Mbps cables listed below. *For 1000 Mbps operation, Category 5E twisted-pair cable is recommended.*
- The port on the **SX-LC mini-GBIC**, which can be installed in the **mini-GBIC XL Module**, transmits at 850 nm wavelength, and is compatible with the IEEE 802.3z Gigabit-SX standard. It accepts the low metal content, multimode fiber-optic cables for Gigabit-SX described on the next page.
- The port on the **LX-LC mini-GBIC**, which can be installed in the **mini-GBIC XL Module**, transmits at 1300 nm wavelength, and is compatible with the IEEE 802.3z Gigabit-LX standard. It accepts the low metal content, single mode or multimode fiber-optic cables for Gigabit-LX described on the next page.

Cables

Twisted-Pair Cables

Port Type	Cable Specifications	Maximum Length
10 Mbps Operation	Category 3, 4, or 5 100-ohm differential unshielded twisted-pair (UTP) or shielded twisted-pair (STP) cable, complying with IEEE 802.3 10Base-T specifications, fitted with RJ-45 connectors	100 meters
100 Mbps Operation	Category 5 100-ohm differential UTP or STP cable, complying with IEEE 802.3u 100Base-TX specifications, fitted with RJ-45 connectors	100 meters
1000 Mbps Operation	Category 5E 100-ohm differential UTP or STP cable, complying with IEEE 802.3ab 1000Base-T specifications, fitted with RJ-45 connectors <i>(please see "Note on 1000Base-T Cable Requirements", on)</i>	100 meters

Fiber-Optic Cables

The following table indicates the characteristics of the fiber-optic cables you should use when connecting to the Gigabit-SX and Gigabit-LX mini-GBICs use in your Series 5300XL Switches. Use cables fitted with LC connectors.

Port Type	Cable Specifications	Maximum Length
Gigabit-SX	62.5/125 μm or 50/125 μm (core/cladding) diameter, graded-index, low metal content, multimode fiber-optic cables, complying with the ITU-T G.651 and ISO/IEC 793-2 Type A1b or A1a respectively.	<ul style="list-style-type: none"> • 62.5 μm cable: <ul style="list-style-type: none"> – 160 MHz*km = 220 meters – 200 MHz*km = 275 meters • 50 μm cable: <ul style="list-style-type: none"> – 400 MHz*km = 500 meters – 500 MHz*km = 550 meters
Gigabit-LX	9/125 μm (core/cladding) diameter, 1310 nm, low metal content, single mode fiber-optic cables, complying with the ITU-T G.652 and ISO/IEC 793-2 Type B1 standards. OR the multimode fiber-optic cables listed for Gigabit-SX.	<ul style="list-style-type: none"> • single-mode cable: 10 kilometers • multimode cable: 550 meters

Note: To use multimode cables for Gigabit-LX, a **mode conditioning patch cord** may be needed — see “Mode Conditioning Patch Cord for Gigabit-LX” on page 22 for more information.

Note

1000Base-T Cable Requirements. The Category 5 networking cables that work for 100Base-TX connections should also work for 1000Base-T, but for the most robust connections you should use cabling that complies with the Category 5E specifications, as described in Addendum 5 to the TIA-568-A standard (ANSI/TIA/EIA-568-A-5).

Because of the increased speed provided by 1000Base-T (Gigabit-T), network cable quality is more important than for either 10Base-T or 100Base-TX. Cabling plants being used to carry 1000Base-T networking must comply with the IEEE 802.3ab standards. In particular, the cabling must pass tests for Attenuation, Near-End Crosstalk (NEXT), and Far-End Crosstalk (FEXT). Additionally, unlike the cables for 100Base-TX, the 1000Base-T cables must pass tests for Equal-Level Far-End Crosstalk (ELFEXT), Multiple Disturber ELFEXT, and Return Loss.

When testing your cabling, be sure to include the patch cables that connect the switch and other end devices to the patch panels on your site. The patch cables are frequently overlooked when testing cable and they must also comply with the cabling standards.

Mode Conditioning Patch Cord for Gigabit-LX

The following information applies to installations in which multimode fiber-optic cables are connected to a Gigabit-LX port.

Unlike Gigabit-SX, which connects to only multimode fiber-optic cabling, Gigabit-LX can use either single-mode or multimode cable. Multimode cable has a design characteristic called “Differential Mode Delay”, which requires that the transmission signals be “conditioned” to compensate for the cable design and thus prevent resulting transmission errors. Since Gigabit-SX is designed to operate only with multimode cable, Gigabit-SX mini-GBICs can provide that transmission conditioning internally.

Gigabit-LX mini-GBICs, since they are designed to operate with both single-mode and multimode cable, do not provide the transmission conditioning internally. Thus, under certain circumstances, depending on the cable used and the lengths of the cable runs, an external **Mode Conditioning Patch Cord** may need to be installed between the Gigabit-LX transmitting device and the multimode network cable to provide the transmission conditioning.

If you experience a high number of transmission errors on the Gigabit-LX ports, usually CRC or FCS errors, you may need to install one of these patch cords between the Gigabit-LX port in your switch and your multimode fiber-optic network cabling, *and between the Gigabit-LX transmission device and the network cabling at the other end of the multimode fiber-optic cable run. A patch cord must be installed at both ends.*

The patch cord consists of a short length of single-mode fiber cable coupled to graded-index multimode fiber cable on the transmit side, and only multimode cable on the receive side. The section of single-mode fiber is connected in such a way that it minimizes the effects of the differential mode delay in the multimode cable.

Note

Most of the time, if you are using good quality graded-index multimode fiber cable that adheres to the standards listed on page 21, there should not be a need to use mode conditioning patch cords in your network. This is especially true if the fiber runs in your network are relatively short.

If you are using *single-mode* fiber-optic cabling in your network, there is no need to use mode conditioning patch cords. Connect the single-mode network cable directly to the Gigabit-LX mini-GBIC.

Installing the Patch Cord

As shown in the illustration below, connect the patch cord to the Gigabit-LX mini-GBIC with the section of single-mode fiber plugged in to the Tx (transmit) port. Then, connect the other end of the patch cord to your network cabling patch panel, or directly to the network multimode fiber.

If you connect the patch cord directly to the network cabling, you may need to install a **female-to-female adapter** to allow the cables to be connected together.

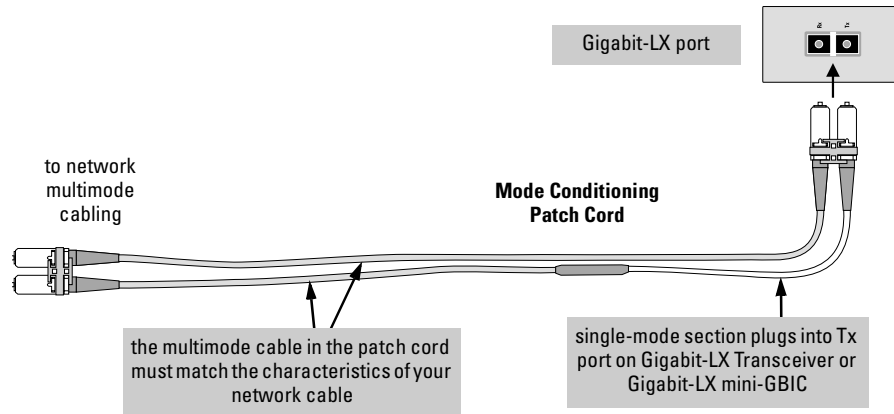

Make sure you purchase a patch cord that has LC connectors on the end that connects to the Gigabit-LX mini-GBIC, and has multimode fibers that match the characteristics of the multimode fiber in your network.

Recommended Patch Cords

Hewlett-Packard maintains a list of recommended Mode Conditioning Patch Cords that have been tested and verified to operate correctly with the HP Procurve Gigabit-LX Transceiver and HP Procurve Gigabit-LX LC mini-GBIC.

The list is on the HP Procurve web site, <http://www.hp.com/go/hpprocurve>, in the Technical Support section.

EMC Regulatory Statements

U.S.A.

FCC Class A

This equipment has been tested and found to comply with the limits for a Class A digital device, pursuant to Part 15 of the FCC Rules. These limits are designed to provide reasonable protection against interference when the equipment is operated in a commercial environment. This equipment generates, uses, and can radiate radio frequency energy and, if not installed and used in accordance with the instruction manual, may cause interference to radio communications. Operation of this equipment in a residential area may cause interference in which case the user will be required to correct the interference at his own expense.

Canada

This product complies with Class A Canadian EMC requirements.

Australia/New Zealand



This product complies with Australia/New Zealand EMC Class A requirements.

Japan

VCCI Class A

この装置は、情報処理装置等電波障害自主規制協議会（VCCI）の基準に基づくクラスA情報技術装置です。この装置を家庭環境で使用すると電波妨害を引き起こすことがあります。この場合には使用者が適切な対策を講ずるよう要求されることがあります。

Korea

사용자 안내문 : A 급기기

이기는 업무용으로 전자파 적합등록을 받은 기기 이오니, 판매자 또는 사용자는 이점을 주의하시기 바라며, 만약 잘못 구입하셨을 때에는 구입한 곳에서 비업무용으로 교환하시기 바랍니다.

Taiwan

警告使用者：這是甲類的資訊產品，在居住的環境中使用時，可能會造成射頻干擾，在這種情況下，使用者會被要求採取某些適當的對策。

European Community Declaration of Conformity

This product is designed for operation with the HP Procurve switches that have XL module slots. Please see the Declarations of Conformity included in the Installation Guides for those products.



Technical information in this document is subject to change without notice.

©Copyright Hewlett-Packard Company, 2001, 2002. All rights reserved. Reproduction, adaptation, or translation without prior written permission is prohibited except as allowed under the copyright laws.

Product of Singapore, April 2002

Manual Part Number
5990-3019

