Chapter 13

Configuring VLANs

This chapter describes how to configure Virtual LANs (VLANs) on the HP 9304M, HP 9308M, and HP 6208M-SX routing switches and the HP 6208M-SX switch.

The “Overview” section provides basic information about the VLAN options. Following this section, other sections provide configuration procedures and examples.

To display configuration information for VLANs, see “Displaying VLAN Information” on page 13-45.

For complete syntax information for the CLI commands shown in this chapter, see the *Command Line Interface Reference*.

Most of the configuration examples in this chapter are based on CLI commands. For Web management procedures, see “Configuring VLANs Using the Web Management Interface” on page 13-38.

Overview

This section describes the VLAN features. Configuration procedures and examples appear in later sections of this chapter.

Types of VLANs

You can configure the following types of VLANs.

- Layer 2 port-based VLAN – a set of physical ports that share a common, exclusive Layer 2 broadcast domain
- Layer 3 protocol VLANs – a subset of ports within a port-based VLAN that share a common, exclusive broadcast domain for Layer 3 broadcasts of the specified protocol type
- IP sub-net VLANs – a subset of ports in a port-based VLAN that share a common, exclusive sub-net broadcast domain for a specified IP sub-net
- IPX network VLANs – a subset of ports in a port-based VLAN that share a common, exclusive network broadcast domain for a specified IPX network
- AppleTalk cable VLANs – a subset of ports in a port-based VLAN that share a common, exclusive network broadcast domain for a specified AppleTalk cable range

When a device receives a packet on a port that is a member of a VLAN, the device forwards the packet based on the following VLAN hierarchy:

- If the port belongs to an IP sub-net VLAN, IPX network VLAN, or AppleTalk cable VLAN, and the packet belongs to the corresponding IP sub-net, IPX network, or AppleTalk cable range, the device forwards the packet to all the ports within that VLAN.
- If the packet is a Layer 3 packet but cannot be forwarded as described above, but the port is a member of a Layer 3 protocol VLAN for the packet's protocol, the device forwards the packet on all the Layer 3 protocol VLAN's ports.
- If the packet cannot be forwarded based on either of the VLAN membership types listed above, but the packet can be forwarded at Layer 2, the device forwards the packet on all the ports within the receiving port's port-based VLAN.

Protocol VLANs differ from IP sub-net, IPX network, and AppleTalk VLANs in an important way. Protocol VLANs accept any broadcast of the specified protocol type. An IP sub-net, IPx network, or AppleTalk VLAN accepts only broadcasts for the specified IP sub-net, IPX network, or AppleTalk cable range.

NOTE: Protocol VLANs are different from IP sub-net, IPX network, and AppleTalk cable VLANs. A port-based VLAN cannot contain both an IP sub-net, IPX network, or AppleTalk cable VLAN and a protocol VLAN for the same protocol. For example, a port-based VLAN cannot contain both an IP protocol VLAN and an IP sub-net VLAN.

Layer 2 Port-Based VLANs

A port-based VLAN is a subset of ports on a device that constitutes a Layer 2 broadcast domain.

By default, all the ports on a device are members of the default VLAN. Thus, all the ports on the device constitute a single Layer 2 broadcast domain. You can configure multiple port-based VLANs. When you configure a port-based VLAN, the device automatically removes the ports you add to the VLAN from the default VLAN.

Figure 13.1 shows an example of a device on which a Layer 2 port-based VLAN has been configured.

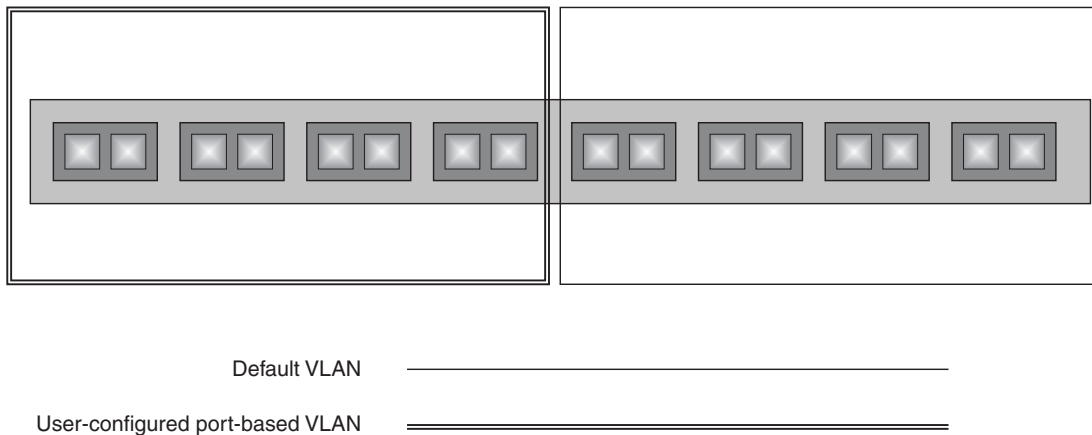

Figure 13.1 Example of a device containing user-defined Layer 2 port-based VLAN

A port can belong to only one port-based VLAN, unless you apply 802.1p tagging to the port. **802.1p tagging** allows the port to add a four-byte tag field, which contains the VLAN ID, to each packet sent on the port. You also can configure port-based VLANs that span multiple devices by tagging the ports within the VLAN. The tag enables each device that receives the packet to determine the VLAN the packet belongs to. 802.1p tagging applies only to Layer 2 VLANs, not to Layer 3 VLANs.

Since each port-based VLAN is a separate Layer 2 broadcast domain, by default each VLAN runs a separate instance of the Spanning Tree Protocol (STP).

Layer 2 traffic is bridged within a port-based VLAN and Layer 2 broadcasts are sent to all the ports within the VLAN.

Layer 3 Protocol-Based VLANs

If you want some or all of the ports within a port-based VLAN to be organized according to Layer 3 protocol, you must configure a Layer 3 protocol-based VLAN within the port-based VLAN.

You can configure each of the following types of protocol-based VLAN within a port-based VLAN. All the ports in the Layer 3 VLAN must be in the same Layer 2 VLAN.

- AppleTalk – The device sends AppleTalk broadcasts to all ports within the AppleTalk protocol VLAN.
- IP – The device sends IP broadcasts to all ports within the IP protocol VLAN.
- IPX – The device sends IPX broadcasts to all ports within the IPX protocol VLAN.
- DECnet – The device sends DECnet broadcasts to all ports within the DECnet protocol VLAN.
- NetBIOS – The device sends NetBIOS broadcasts to all ports within the NetBIOS protocol VLAN.
- Other – The device sends broadcasts for all protocol types other than those listed above to all ports within the VLAN.

Figure 13.2 shows an example of Layer 3 protocol VLANs configured within a Layer 2 port-based VLAN.

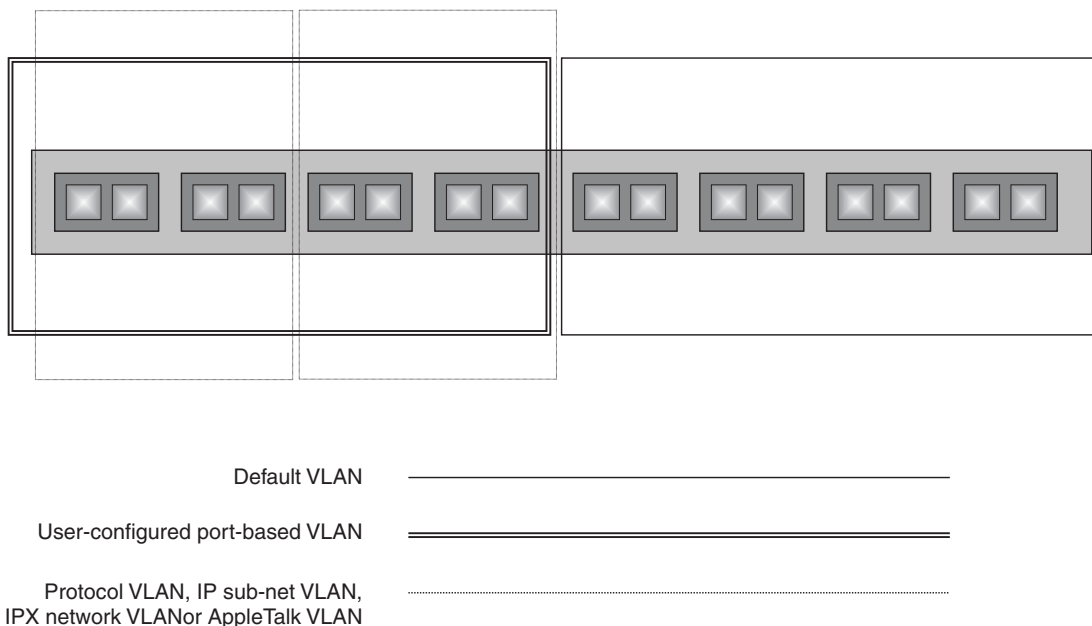

Figure 13.2 Layer 3 protocol VLANs within a Layer 2 port-based VLAN

Integrated Switch Routing (ISR)

The **Integrated Switch Routing (ISR)** feature enables VLANs configured on routing switches to route Layer 3 traffic from one protocol VLAN or IP sub-net, IPX network, or AppleTalk cable VLAN to another. Normally, to route traffic from one IP sub-net, IPX network, or AppleTalk cable VLAN to another, you would need to forward the traffic to an external router. The VLANs provide Layer 3 broadcast domains for these protocols but do not in themselves provide routing services for these protocols. This is true even if the source and destination IP sub-nets, IPX networks, or AppleTalk cable ranges are on the same device.

ISR eliminates the need for the external router by allowing you to route between the VLANs, on the same device, using virtual interfaces (VEs).¹ A **virtual interface** is a logical port on which you can configure Layer 3 routing parameters. You configure a separate virtual interface on each VLAN that you want to be able to route from or to.

For example, if you configure two IP sub-net VLANs on a routing switch, you can configure a virtual interface on each VLAN, then configure IP routing parameters for the sub-nets. Thus, the routing switch forwards IP sub-net broadcasts within each VLAN at Layer 2 but routes Layer 3 traffic between the VLANs using the virtual interfaces.

The routing parameters and the syntax for configuring them are the same as when you configure a physical interface for routing. The logical interface allows the routing switch to internally route traffic between the protocol-based VLANs without using physical interfaces.

All the ports within a protocol-based VLAN must be in the same port-based VLAN. The protocol-based VLAN cannot have ports in multiple port-based VLANs, unless the ports in the port-based VLAN to which you add the protocol-based VLAN are 802.1p tagged.

You can configure multiple protocol-based VLANs within the same port-based VLAN. In addition, a port within a port-based VLAN can belong to multiple protocol-based VLANs of the same type or different types. For example, if you have a port-based VLAN that contains ports 1 – 10, you can configure port 5 as a member of an AppleTalk protocol VLAN, an IP protocol VLAN, and an IPX protocol VLAN, and so on.

IP Sub-Net, IPX Network, and AppleTalk Cable VLANs

The protocol-based VLANs described in the previous section provide separate protocol broadcast domains for specific protocols. For IP, IPX, and AppleTalk, you can provide more granular broadcast control by instead creating the following types of VLAN:

- **IP sub-net VLAN** – An IP sub-net broadcast domain for a specific IP sub-net.
- **IPX network VLAN** – An IPX network broadcast domain for a specific IPX network.
- **AppleTalk cable VLAN** – An AppleTalk broadcast domain for a specific cable range.

You can configure these types of VLANs on routing switches only. The routing switch sends broadcasts for the IP sub-net, IPX network, or AppleTalk cable range to all ports within the IP sub-net, IPX network, or AppleTalk cable VLAN at Layer 2.

The routing switch routes packets between VLANs at Layer 3. To configure an IP sub-net, IPX network, or AppleTalk cable VLAN to route, you must add a virtual interface to the VLAN, then configure the appropriate routing parameters on the virtual interface.

NOTE: The routing switch routes packets between VLANs of the same protocol. The routing switch cannot route from one protocol to another.

NOTE: IP sub-net VLANs are not the same thing as IP protocol VLANs. An IP protocol VLAN sends all IP broadcasts on the ports within the IP protocol VLAN. An IP sub-net VLAN sends only the IP sub-net broadcasts for the sub-net of the VLAN. You cannot configure an IP protocol VLAN and an IP sub-net VLAN within the same port-based VLAN.

This note also applies to IPX protocol VLANs and IPX network VLANs, and to AppleTalk protocol VLANs and AppleTalk cable VLANs.

1.The acronym “VE” stands for “Virtual Ethernet”.

Default VLAN

By default, all the ports on a device are in a single port-based VLAN. This VLAN is called DEFAULT-VLAN and is VLAN number 1. The routing switches and the switch do not contain any protocol VLANs or IP sub-net, IPX network, or AppleTalk cable VLANs by default.

Figure 13.3 shows an example of the default Layer 2 port-based VLAN.

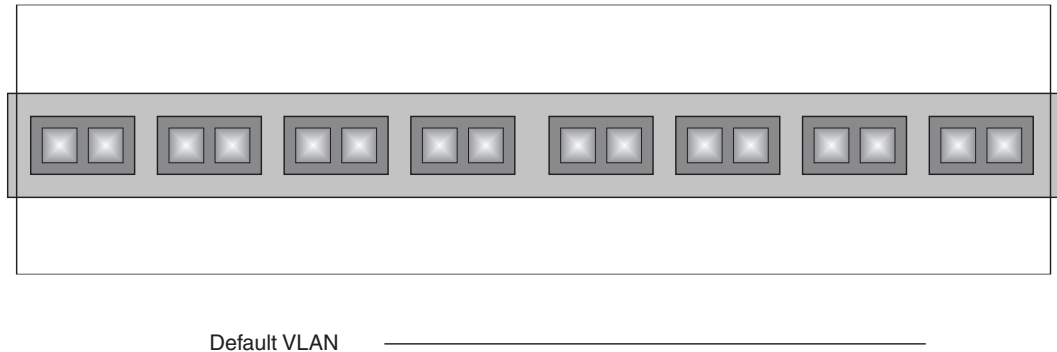

Figure 13.3 Default Layer 2 port-based VLAN

When you configure a port-based VLAN, one of the configuration items you provide is the ports that are in the VLAN. When you configure the VLAN, the device automatically removes the ports that you place in the VLAN from DEFAULT-VLAN. By removing the ports from the default VLAN, the device ensures that each port resides in only one Layer 2 broadcast domain.

NOTE: Information for the default VLAN is available only after you define another VLAN.

Some network configurations may require that a port be able to reside in two or more Layer 2 broadcast domains (port-based VLANs). In this case, you can enable a port to reside in multiple port-based VLANs by tagging the port. See the following section.

If your network requires that you use VLAN ID 1 for a user-configured VLAN, you can reassign the default VLAN to another valid VLAN ID. See “Assigning a Different VLAN ID to the Default VLAN” on page 13-13.

802.1p Tagging

802.1p tagging is an IEEE standard that allows a networking device to add information to a Layer 2 packet in order to identify the VLAN membership of the packet. The routing switches and the switch tag a packet by adding a four-byte tag to the packet. The tag contains the tag value, which identifies the data as a tag, and also contains the VLAN ID of the VLAN from which the packet is sent.

- The default tag value is 8100. This value comes from the 802.1p specification. You can change this tag value on a global basis if needed to be compatible with other vendors' equipment.
- The VLAN ID is determined by the VLAN on which the packet is being forwarded.

Figure 13.4 shows the format of packets with and without the 802.1p tag. The tag format is vendor-specific. To use the tag for VLANs configured across multiple devices, make sure all the devices support the same tag format.

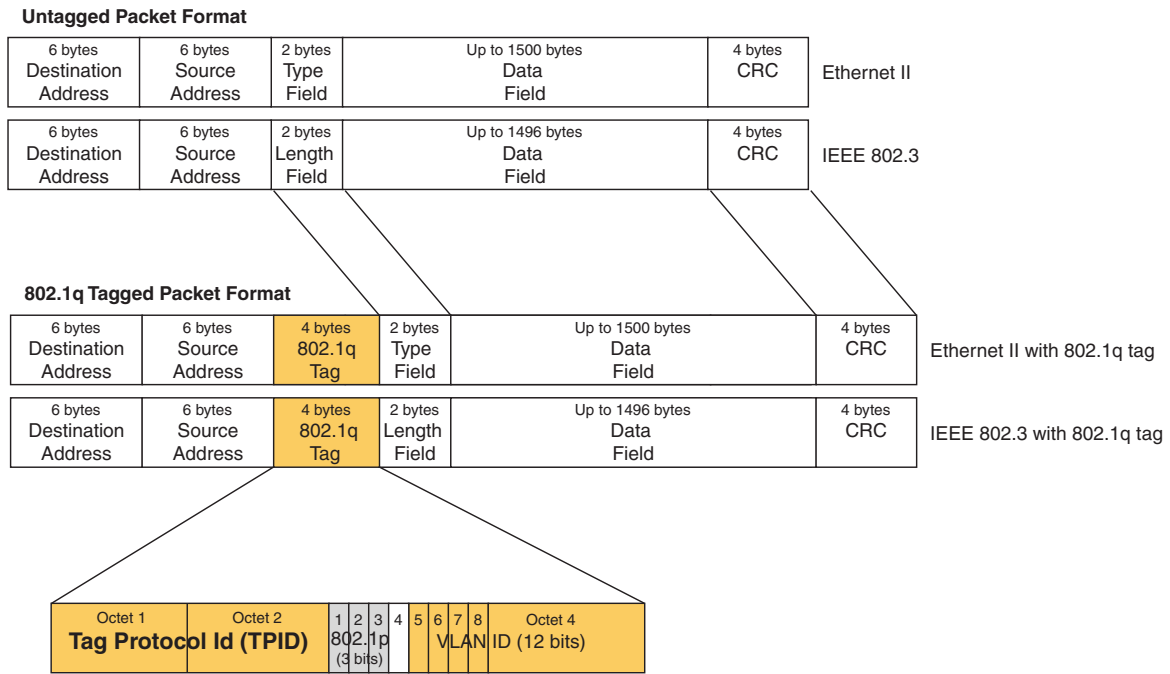

Figure 13.4 Packet containing the 802.1Q VLAN tag

NOTE: You cannot configure a port to be a member of the default port-based VLAN and another port-based VLAN at the same time. Once you add a port to a port-based VLAN, the port is no longer a member of the default VLAN. The port returns to the default VLAN only if you delete the other VLAN(s) that contains the port.

If you configure a VLAN that spans multiple devices, you need to use tagging only if a port connecting one of the devices to the other is a member of more than one port-based VLAN. If a port connecting one device to the other is member of only a single port-based VLAN, tagging is not required.

If you use tagging on multiple devices, each device must be configured for tagging and must use the same tag value. In addition, the implementation of tagging must be compatible on the devices.

Figure 13.5 shows an example of two devices that have the same Layer 2 port-based VLANs configured across them. Notice that only one of the VLANs requires tagging.

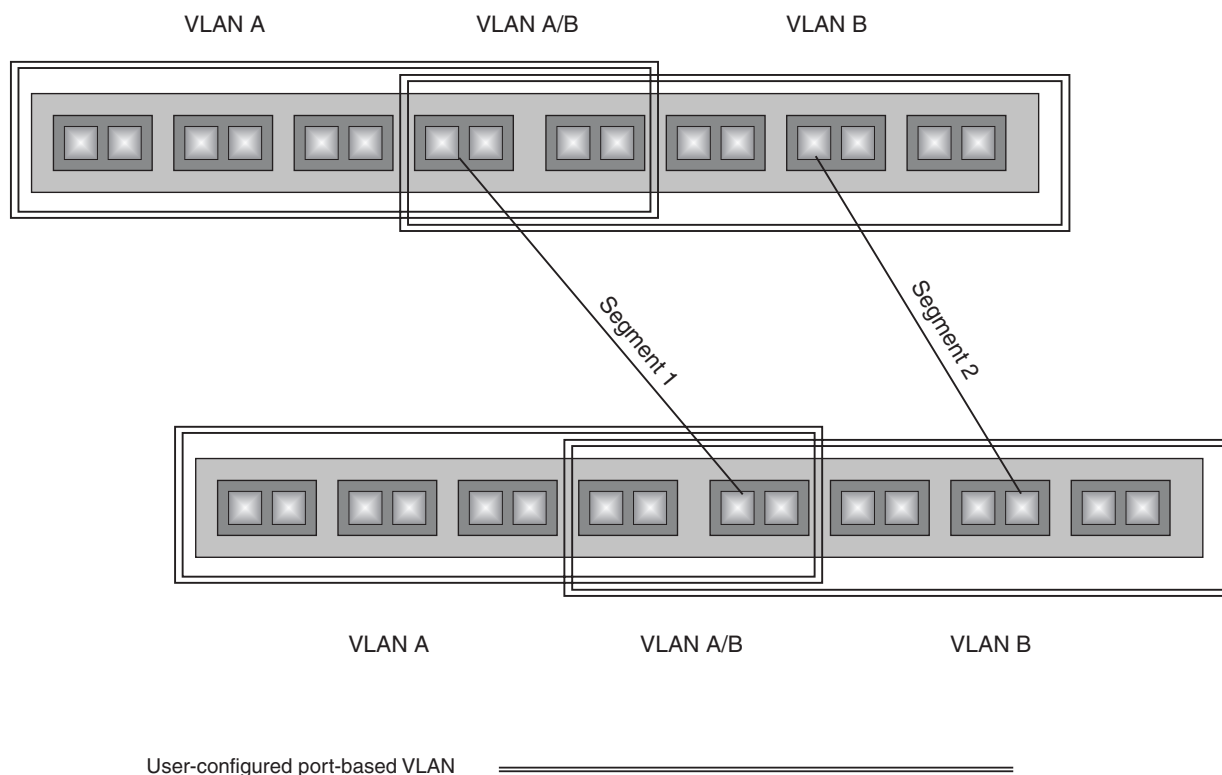

Figure 13.5 VLANs configured across multiple devices

Spanning Tree Protocol (STP)

The default state of STP depends on the device type:

- STP is disabled by default on the HP 9304M, HP 9308M, and HP 6208M-SX routing switches.
- STP is enabled by default on the HP 6208M-SX switch.

Also by default, each port-based VLAN has a separate instance of STP. Thus, when STP is globally enabled, each port-based VLAN on the device runs a separate spanning tree.

You can enable or disable STP on the following levels:

- Globally – Affects all ports on the device.

NOTE: When you configure a VLAN, the VLAN inherits the global STP settings. However, once you begin to define a VLAN, you can no longer configure STP globally. From that point on, you can configure STP only within individual VLANs.

- Port-based VLAN – Affects all ports within the specified port-based VLAN. When you enable or disable STP within a port-based VLAN, the setting overrides the global setting. Thus, you can enable STP for the ports within a port-based VLAN even when STP is globally disabled, or disable the ports within a port-based VLAN when STP is globally enabled.

STP is a Layer 2 protocol. Thus, you cannot enable or disable STP for individual protocol VLANs or for IP sub-net, IPX network, or AppleTalk cable VLANs. The STP state of a port-based VLAN containing these other types of VLANs determines the STP state for all the Layer 2 broadcasts within the port-based VLAN. This is true even though Layer 3 protocol broadcasts are sent on Layer 2 within the VLAN.

It is possible that STP will block one or more ports in a protocol VLAN that uses a virtual interface to route to other VLANs. For IP protocol and IP sub-net VLANs, even though some of the physical ports of the virtual interface are

blocked, the virtual interface can still route so long as at least one port in the virtual interface's protocol VLAN is not blocked by STP.

NOTE: If you plan to connect the device to networking devices that run only a single instance of STP on all ports, you can configure the device to run a single instance of STP on all ports. However, doing so causes the device to stop using the individual VLANs you have configured and instead places all ports in a single logical VLAN, which is VLAN 4094. See the addendum or release notes shipped with your product for information.

Virtual Interfaces

A virtual interface is a logical routing interface that routing switches use to route Layer 3 protocol traffic between protocol VLANs.

The routing switches send Layer 3 traffic at Layer 2 within a protocol VLAN. However, Layer 3 traffic from one protocol VLAN to another must be routed.

If you want the device to be able to send Layer 3 traffic from one protocol VLAN to another, you must configure a virtual interface on each protocol VLAN, then configure routing parameters on the virtual interfaces. For example, to enable a routing switch to route IP traffic from one IP sub-net VLAN to another, you must configure a virtual interface on each IP sub-net VLAN, then configure the appropriate IP routing parameters on each of the virtual interfaces.

Figure 13.6 shows an example of Layer 3 protocol VLANs that use virtual interfaces for routing.

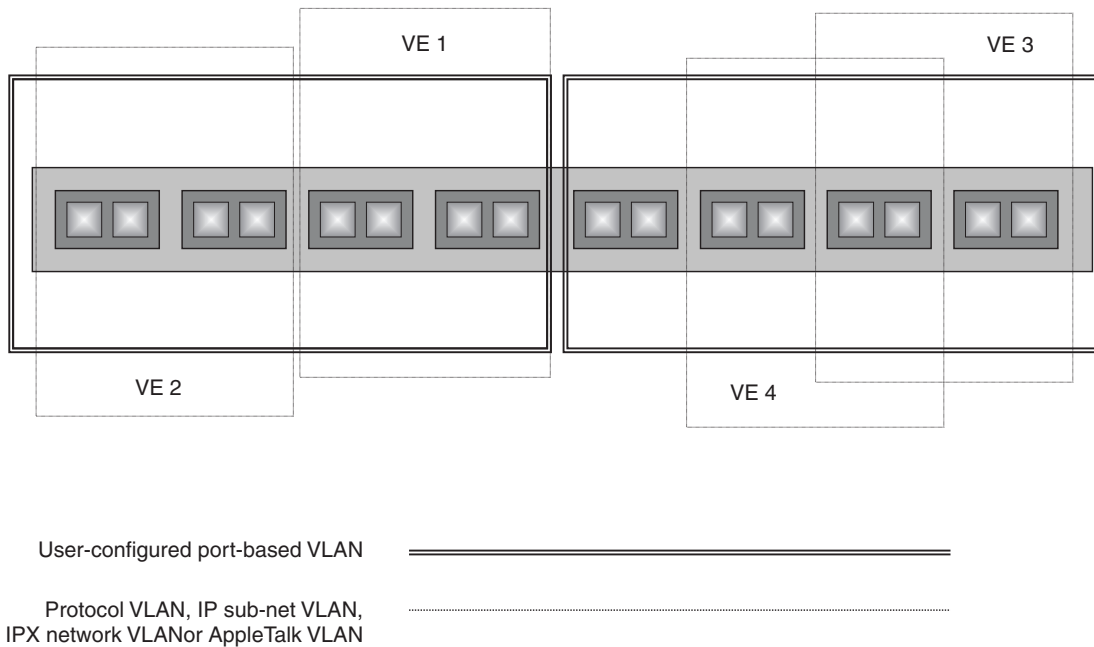

Figure 13.6 Use virtual interfaces for routing between Layer 3 protocol VLANs

Dynamic, Static, and Excluded Port Membership

When you add ports to a protocol VLAN, IP sub-net VLAN, IPX network VLAN, or AppleTalk cable VLAN, you can add them dynamically or statically:

- Dynamic ports
- Static ports

You also can explicitly exclude ports.

Dynamic Ports

Dynamic ports are added to a VLAN when you create the VLAN. However, if a dynamically added port does not receive any traffic for the VLAN's protocol within ten minutes, the port is removed from the VLAN. However, the port remains a candidate for port membership. Thus, if the port receives traffic for the VLAN's protocol, the device adds the port back to the VLAN.

After the port is added back to the VLAN, the port can remain an active member of the VLAN up to 20 minutes without receiving traffic for the VLAN's protocol. If the port ages out, it remains a candidate for VLAN membership and is added back to the VLAN when the VLAN receives protocol traffic. At this point, the port can remain in the VLAN up to 20 minutes without receiving traffic for the VLAN's protocol, and so on.

Unless you explicitly add a port statically or exclude a port, the port is a dynamic port and thus can be an active member of the VLAN, depending on the traffic it receives.

NOTE: You cannot configure dynamic ports in an AppleTalk cable VLAN. The ports in an AppleTalk cable VLAN must be static. However, ports in an AppleTalk protocol VLAN can be dynamic or static.

Figure 13.7 shows an example of a VLAN with dynamic ports. Dynamic ports not only join and leave the VLAN according to traffic, but also allow some broadcast packets of other protocol types to “leak” through the VLAN. See “Broadcast Leaks” on page 13-10.

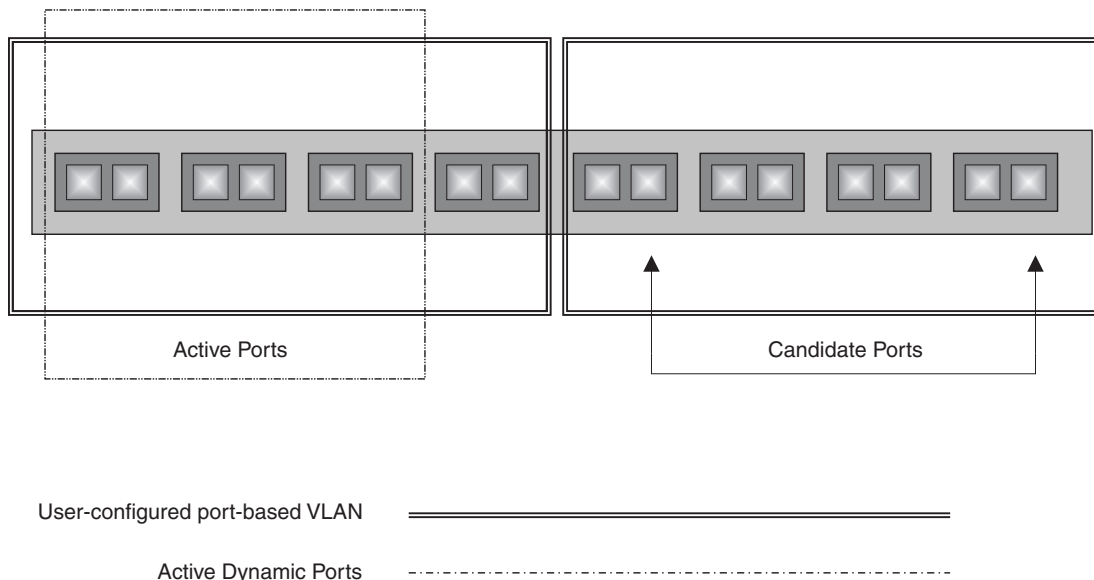

Figure 13.7 VLAN with dynamic protocol ports—all ports are active when you create the VLAN

Ports in a new protocol VLAN that do not receive traffic for the VLAN's protocol age out after 10 minutes and become candidate ports.

Static Ports

Static ports are permanent members of the protocol VLAN. The ports remain active members of the VLAN regardless of whether the ports receive traffic for the VLAN's protocol. You must explicitly identify the port as a static port when you add it to the VLAN. Otherwise, the port is dynamic and is subject to aging out.

In addition, static ports never “leak” broadcast packets of other protocol types. (See “Broadcast Leaks” on page 13-10.)

Excluded Ports

If you want to prevent a port in a port-based VLAN from ever becoming a member of a protocol, IP sub-net, IPX network, or AppleTalk cable VLAN configured in the port-based VLAN, you can explicitly exclude the port. You exclude the port when you configure the protocol, IP sub-net, IPX network, or AppleTalk cable VLAN.

Broadcast Leaks

Dynamic ports differ from static ports in an important way. Static ports never allow broadcasts for protocols other than the protocol of the VLAN to be forwarded on the port. Thus, an IP protocol VLAN forwards only IP broadcast packets and never broadcasts any Layer 3 broadcasts of other protocol types. If you want to ensure that no broadcasts other than those of the VLAN's protocol get through, use static ports.

Dynamic ports “leak” every eighth broadcast packet of another protocol type through the port. Thus, if an IP protocol VLAN receives eight AppleTalk broadcast packets, the VLAN port drops the first seven packets but sends the eighth packet. This behavior enables a PC, Macintosh computer, or workstation that joins the network to find its servers, even if the LAN segment the device is on is configured as part of a protocol VLAN for a different protocol. For example, if a few of your network users have Macintosh computers, they can still find their printers or other servers even if the network segment they are on is part of an IP protocol VLAN.

The VLAN ports maintain separate counters for each protocol. Thus, if a port in an IP protocol VLAN receives four AppleTalk broadcast packets and four DECnet broadcast packets, the port still does not forward any of the packets. Only when the port receives eight AppleTalk broadcast packets or eight DECnet broadcast packets does the port send the eighth packet of that protocol type.

Figure 13.8 shows an example of a Layer 3 IP protocol VLAN with dynamic ports. Since the ports have dynamic membership, they are “leaky”. They forward every eighth broadcast packet of non-IP protocols. For example, when the Macintosh computer sends its eighth broadcast packet, the VLAN forwards the packet. In a VLAN with static ports, the VLAN never forwards broadcast packets of other protocol types.

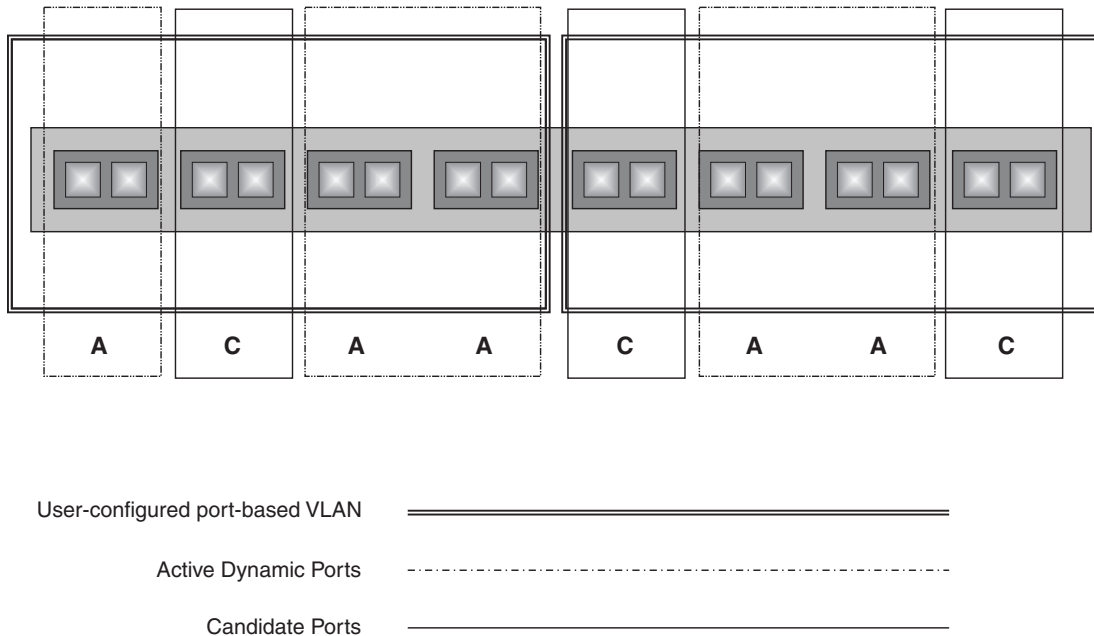

Figure 13.8 Protocol VLAN with “leaky” (dynamic) ports

Trunk Group Ports and VLAN Membership

A trunk group is a set of physical ports that are configured to act as a single physical interface. Each trunk group's port configuration is based on the configuration of the lead port, which is the lowest numbered port in the group.

If you add a trunk group's lead port to a VLAN, all of the ports in the trunk group become members of that VLAN.

Summary of VLAN Configuration Rules

A hierarchy of VLANs exists between the Layer 2 and Layer 3 protocol-based VLANs:

- Port-based VLANs are at the lowest level of the hierarchy.
- Layer 3 protocol-based VLANs, IP, IPX, AppleTalk, Decnet, and NetBIOS are at the middle level of the hierarchy.
- IP sub-net, IPX network, and AppleTalk cable VLANs are at the top of the hierarchy.

NOTE: You cannot have a protocol-based VLAN and a sub-net or network VLAN of the same protocol type in the same port-based VLAN. For example, you can have an IPX protocol VLAN and IP sub-net VLAN in the same port-based VLAN, but you cannot have an IP protocol VLAN and an IP sub-net VLAN in the same port-based VLAN, nor can you have an IPX protocol VLAN and an IPX network VLAN in the same port-based VLAN.

As a device receives packets, the VLAN classification starts from the highest level VLAN first. Therefore, if an interface is configured as a member of both a port-based VLAN and an IP protocol VLAN, IP packets coming into the interface are classified as members of the IP protocol VLAN because that VLAN is higher in the VLAN hierarchy.

Multiple VLAN Membership Rules

- A port can belong to multiple, unique, overlapping Layer 3 protocol-based VLANs without VLAN tagging.
- A port can belong to multiple, overlapping Layer 2 port-based VLANs only if the port is a tagged port. Packets sent out of a tagged port use an 802.1p-tagged frame.
- When both port and protocol-based VLANs are configured on a given device, all protocol VLANs must be strictly contained within a port-based VLAN. A protocol VLAN cannot include ports from multiple port-based VLANs. This rule is required to ensure that port-based VLANs remain loop-free Layer 2 broadcast domains.
- IP-Protocol and IP-Subnet VLANs cannot operate concurrently on the system or within the same port-based VLAN.
- IPX-Protocol and IPX-Network VLANs cannot operate concurrently on the system or within the same port-based VLAN.
- If you first configure IP and IPX protocol VLANs before deciding to partition the network by IP sub-net and IPX network VLANs, then you need to delete those VLANs before creating the IP sub-net and IPX network VLANs.
- One of each type of protocol VLAN is configurable within each port-based VLAN on the switch.
- Multiple IP-Subnet and IPX-Network VLANs are configurable within each port-based VLAN on the switch.
- Removing a configured port-based VLAN from a routing switch or switch automatically removes any protocol-based VLAN, IP-Subnet VLAN, AppleTalk cable VLAN, or IPX-Network VLAN, or any virtual interfaces defined within the Port-based VLAN.

Routing Between VLANs (Routing Switches Only)

The routing switches can locally route IP, IPX, and Appletalk between VLANs defined within a single routing switch. All other routable protocols or protocol VLANs (for example, DecNet) must be routed by another external router capable of routing the protocol.

Virtual Interfaces (Routing Switches Only)

Virtual interfaces must be defined at the highest level of the VLAN hierarchy. You need to configure virtual interfaces if an IP, IPX, or Appletalk protocol VLAN, IP sub-net VLAN, AppleTalk cable VLAN, or IPX network VLAN is defined within a port-based VLAN on a routing switch. You also you need to route these protocols to another port-based VLAN on the same routing switch. You need to configure a separate virtual interface within each of the protocol, subnet or network VLANs that are defined to the port-based VLAN. This configuration would require three virtual interfaces for a single port-based VLAN.

If you do not need to further partition the port-based VLAN by defining separate Layer 3 VLANs, you can define a single virtual interface at the port-based VLAN level and enable IP, IPX, and Appletalk routing on a single virtual interface.

Bridging and Routing the Same Protocol Simultaneously on the Same Device (Routing Switches Only)

Some configurations may require simultaneous switching and routing of the same single protocol across different sets of ports on the same routing switch. When IP, IPX, or Appletalk routing is enabled on a routing switch, you can route these protocols on specific interfaces while bridging them on other interfaces. In this scenario, you can create two separate backbones for the same protocol, one bridged and one routed.

To bridge IP, IPX, or Appletalk at the same time these protocols are being routed, you need to configure an IP protocol, IP sub-net, IPX protocol, IPX network, or Appletalk protocol VLAN and not assign a virtual interface to the VLAN. Packets for these protocols are bridged or switched at Layer 2 across ports on the routing switch that are included in the Layer 3 VLAN. If these VLANs are built within port-based VLANs, they can be tagged across a single set of backbone fibers to create separate Layer 2 switched and Layer 3 routed backbones for the same protocol on a single physical backbone.

Routing Between VLANs Using Virtual Interfaces (Routing Switches Only)

The *Integrated Switch Routing (ISR)* feature allows routing switches to route between VLANs. There are some important concepts to understand before designing an ISR backbone.

Virtual interfaces can be defined on port-based, IP protocol, IP sub-net, IPX protocol, IPX network, AppleTalk protocol, and AppleTalk cable VLANs.

To create any type of VLAN on a routing switch, Layer 2 forwarding must be enabled. When Layer 2 forwarding is enabled, the routing switch becomes a Layer 2 switch on all ports for all non-routable protocols.

If the router interfaces for IP, IPX, or AppleTalk are configured on physical ports, then routing occurs independent of the Spanning Tree Protocol (STP). However, if the router interfaces are defined for any type VLAN, they are virtual interfaces and are subject to the rules of STP.

If your backbone is comprised of virtual interfaces all within the same STP domain, it is a bridged backbone, not a routed one. This means that the set of backbone interfaces that are blocked by STP will be blocked for routed protocols as well. The routed protocols will be able to cross these paths only when the STP state of the link is FORWARDING. This problem is easily avoided by proper network design.

When designing an ISR network, pay attention to your use of virtual interfaces and the spanning-tree domain. If Layer 2 switching of your routed protocols (IP, IPX, AppleTalk) is not required across the backbone, then the use of virtual interfaces can be limited to edge switch ports within each routing switch. Full backbone routing can be achieved by configuring routing on each physical interface that connects to the backbone. Routing is independent of STP when configured on a physical interface.

If your ISR design requires that you switch IP, IPX, or Appletalk at Layer 2 while simultaneously routing the same protocols over a single backbone, then create multiple port-based VLANs and use VLAN tagging on the backbone links to separate your Layer 2 switched and Layer 3 routed networks.

There is a separate STP domain for each port-based VLAN. Routing occurs independently across port-based VLANs or STP domains. You can define each end of each backbone link as a separate tagged port-based VLAN. Routing will occur independently across the port-based VLANs. Because each port-based VLAN's STP domain is a single point-to-point backbone connection, you are guaranteed to never have an STP loop. STP will never block the virtual interfaces within the tagged port-based VLAN, and you will have a fully routed backbone.

Assigning a Different VLAN ID to the Default VLAN

When you enable port-based VLANs, all ports in the system are added to the default VLAN. By default, the default VLAN ID is "VLAN 1". The default VLAN is not configurable. If you want to use the VLAN ID "VLAN 1" as a configurable VLAN, you can assign a different VLAN ID to the default VLAN.

To reassign the default VLAN to a different VLAN ID, enter the following command:

```
HP9300(config)# default-vlan-id 4095
```

Syntax: default-vlan-d <vlan-id>

You must specify a valid VLAN ID that is not already in use. For example, if you have already defined VLAN 10, do not try to use "10" as the new VLAN ID for the default VLAN. Valid VLAN IDs are numbers from 1 – 4095.

NOTE: Changing the default VLAN name does not change the properties of the default VLAN. Changing the name allows you to use the VLAN ID "1" as a configurable VLAN.

Assigning Trunk Group Ports

When a "lead" trunk group port is assigned to a VLAN, all other members of the trunk group are automatically added to that VLAN. A lead port is the first port of a trunk group port range; for example, "1" in 1 – 4 or "5" in 5 – 8. See "Configuring Trunk Groups" in the "Configuring Basic Features" chapter of Book 1.

Configuring Port-Based VLANs

Port-based VLANs allow you to provide separate spanning tree protocol (STP) domains or broadcast domains on a port-by-port basis.

This section describes how to perform the following tasks for port-based VLANs using the CLI:

- Create a VLAN.
- Delete a VLAN.
- Modify a VLAN.
- Assign a higher priority to the VLAN.
- Change a VLAN's priority.
- Enable or disable STP on the VLAN.

EXAMPLE:

Figure 13.9 shows a simple port-based VLAN configuration using a single HP 6208M-SX switch. All ports within each VLAN are untagged. One untagged port within each VLAN is used to connect the switch to a routing switch (in this example, an HP 6308M-SX) for Layer 3 connectivity between the two port-based VLANs.

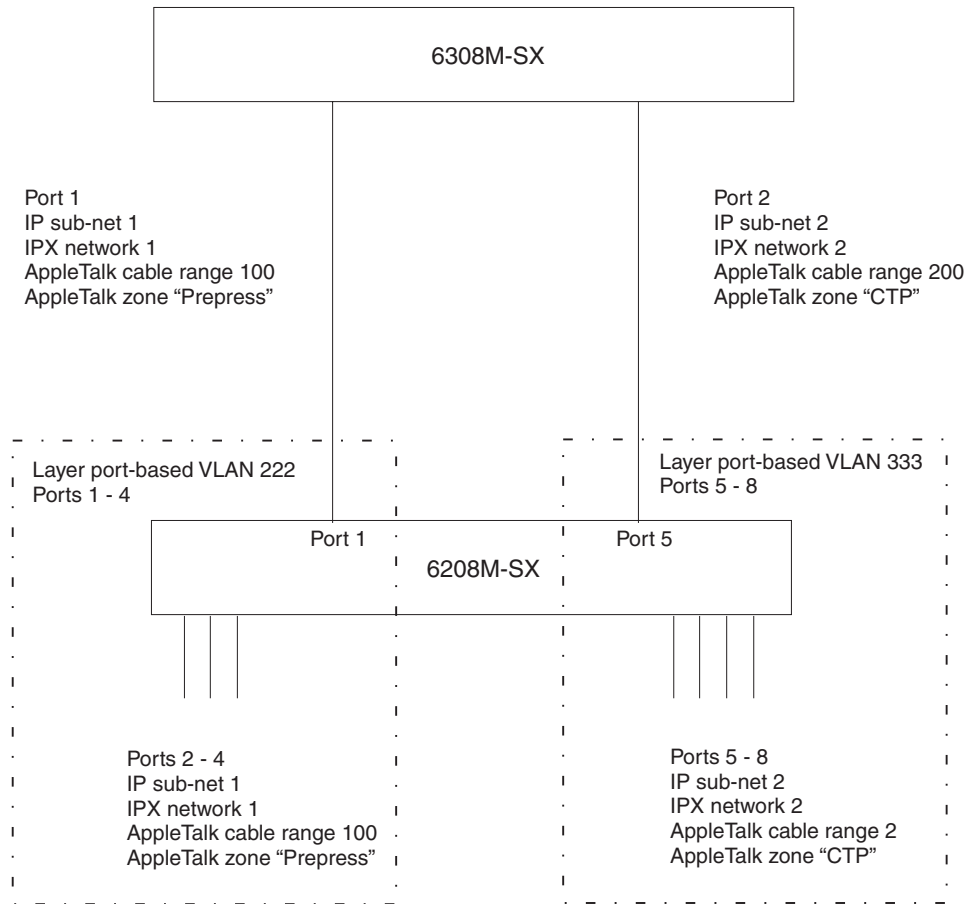

Figure 13.9 Port-based VLANs 222 and 333

To create the two port-based VLANs shown in Figure 13.9, use the following method.

USING THE CLI

```
HP6208(config)# vlan 222 by port
HP6208(config-vlan-222)# untag e1 to 4
HP6208(config-vlan-222)# vlan 333 by port
HP6208(config-vlan-333)# untag e5 to 8
HP6208(config-vlan-333)# write memory
```

Syntax: vlan <vlan-id> by port

Syntax: untagged ethernet <portnum> [to <portnum> | ethernet <portnum>]

EXAMPLE:

Figure 13.10 shows a more complex port-based VLAN configuration using multiple switches and IEEE 802.1p VLAN tagging. The backbone link connecting the three switches is tagged. One untagged port within each port-based VLAN on 6208M-SX A connects each separate network-wide Layer 2 broadcast domain to the routing switch for Layer 3 forwarding between broadcast domains. The STP priority is configured to force 6208M-SX A to be the root bridge for VLAN BROWN. The STP priority on 6208M-SX B is configured so that 6208M-SX B is the root bridge for VLAN GREEN.

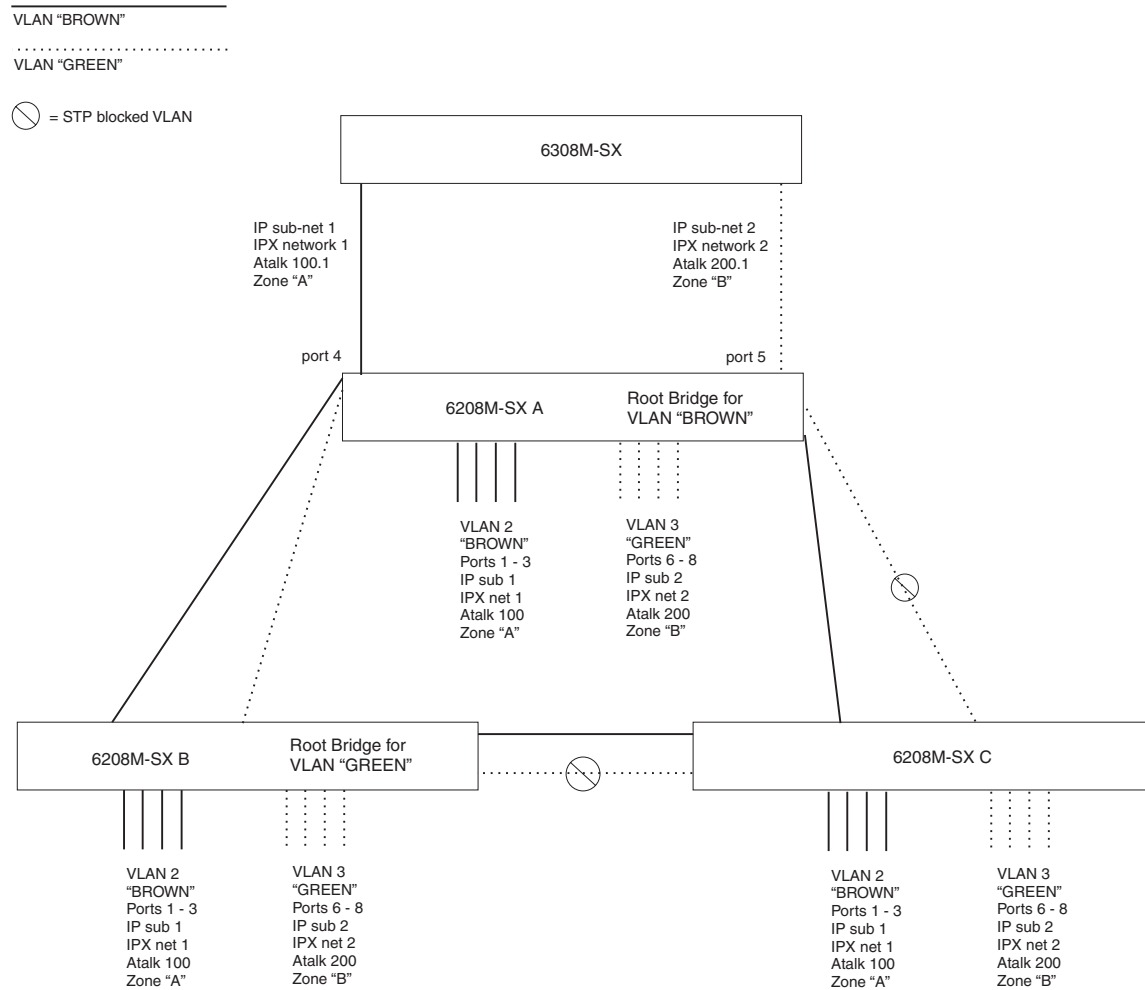

Figure 13.10 More complex port-based VLAN

To configure the Port-based VLANs on the HP 6208M-SX switches in Figure 13.10, use the following method.

USING THE CLI

Configuring 6208M-SX A

Enter the following commands to configure 6208M-SX A:

```
HP6208> enable
HP6208# configure terminal
HP6208(config)# hostname HP6208-A
HP6208-A(config)# vlan 2 name BROWN
HP6208-A(config-vlan-2)# untag ethernet 1 to 4
HP6208-A(config-vlan-2)# tag ethernet 7 to 8
HP6208-A(config-vlan-2)# spanning-tree
HP6208-A(config-vlan-2)# vlan 3 name GREEN
HP6208-A(config-vlan-3)# untag ethernet 4 to 6 ethernet 8
```

```
HP6208-A(config-vlan-3)# tag ethernet 7 to 8
HP6208-A(config-vlan-3)# spanning-tree
HP6208-A(config-vlan-3)# write memory
```

Configuring 6208M-SX B

Enter the following commands to configure 6208M-SX B:

```
HP6208> en
HP6208# configure terminal
HP6208(config)# hostname HP6208-B
HP6208-B(config)# vlan 2 name BROWN
HP6208-B(config-vlan-2)# untag ethernet 1 to 3
HP6208-B(config-vlan-2)# tag ethernet 7 to 8
HP6208-B(config-vlan-2)# spanning-tree
HP6208-B(config-vlan-2)# spanning-tree priority 500
HP6208-B(config-vlan-2)# vlan 3 name GREEN
HP6208-B(config-vlan-3)# untag ethernet 4 to 6
HP6208-B(config-vlan-3)# tag ethernet 7 to 8
HP6208-B(config-vlan-3)# spanning-tree
HP6208-B(config-vlan-3)# spanning-tree priority 500
HP6208-B(config-vlan-3)# write memory
```

Configuring 6208M-SX C

Enter the following commands to configure 6208M-SX C:

```
HP6208> en
HP6208# configure terminal
HP6208(config)# hostname HP6208-C
HP6208-C(config)# vlan 2 name BROWN
HP6208-C(config-vlan-2)# untag ethernet 1 to 3
HP6208-C(config-vlan-2)# tag ethernet 7 to 8
HP6208-C(config-vlan-2)# vlan 3 name GREEN
HP6208-C(config-vlan-3)# untag ethernet 4 to 6
HP6208-C(config-vlan-3)# tag ethernet 7 to 8
HP6208-C(config-vlan-5)# write memory
```

Syntax: vlan <vlan-id> by port

Syntax: untagged ethernet <portnum> [to <portnum> | ethernet <portnum>]

Syntax: tagged ethernet <portnum> [to <portnum> | ethernet <portnum>]

Syntax: [no] spanning-tree

Syntax: spanning-tree [ethernet <portnum> path-cost <value> priority <value>] forward-delay <value> hello-time <value> maximum-age <time> priority <value>

Modifying a Port-Based VLAN

You can make the following modifications to a port-based VLAN:

- Add or delete a VLAN port.
- Change its priority.
- Enable or disable STP.

Removing a Port-Based VLAN

Suppose you want to remove VLAN 5 from the example in Figure 13.10. To do so, use the following procedure.

USING THE CLI

1. Access the global CONFIG level of the CLI on 6208M-SX A by entering the following commands:

```
HP6208-A> enable
No password has been assigned yet...
HP6208-A# configure terminal
HP6208-A(config)#
```

2. Enter the following command:

```
HP6208-A(config)# no vlan 5
HP6208-A(config)#
```

3. Enter the following commands to exit the CONFIG level and save the configuration to the system-config file on flash memory:

```
HP6208-A(config)#
HP6208-A(config)# end
HP6208-A# write memory
HP6208-A#
```

4. Repeat steps 1 – 3 on 6208M-SX B.

Syntax: no vlan <vlan-id> by port

Removing a Port from a VLAN

Suppose you want to remove port 11 from VLAN 4 on 6208M-SX A shown in Figure 13.10. To do so, use the following procedure.

USING THE CLI

1. Access the global CONFIG level of the CLI on 6208M-SX A by entering the following command:

```
HP6208-A> enable
No password has been assigned yet...
HP6208-A# configure terminal
HP6208-A(config)#
```

2. Access the level of the CLI for configuring port-based VLAN 4 by entering the following command:

```
HP6208-A(config)#
HP6208-A(config)# vlan 4
HP6208-A(config-vlan-4)#
```

3. Enter the following commands:

```
HP6208-A(config-vlan-4)#
HP6208-A(config-vlan-4)# no untag ethernet 11
deleted port ethe 11 from port-vlan 4.
HP6208-A(config-vlan-4)#
```

4. Enter the following commands to exit the VLAN CONFIG mode and save the configuration to the system-config file on flash memory:

```
HP6208-A(config-vlan-4)#  
HP6208-A(config-vlan-4)# end  
HP6208-A# write memory  
HP6208-A#
```

Assigning a Higher Priority to a VLAN

Suppose you wanted to give all traffic on Purple VLAN 2 in Figure 13.10 higher priority than all the other VLANs. Use the following procedure to do so.

USING THE CLI

1. Access the global CONFIG level of the CLI on 6208M-SX A by entering the following command:

```
HP6208-A> enable  
No password has been assigned yet...  
HP6208-A# configure terminal  
HP6208-A(config)#
```

2. Access the level of the CLI for configuring port-based VLAN 2 by entering the following command:

```
HP6208-A(config)#  
HP6208-A(config)# vlan 2  
HP6208-A(config-vlan-2)#
```

3. Enable all packets exiting the switch on VLAN 2 to transmit from the high priority hardware queue of each transmit interface. Possible QoS priority levels are 0 (normal) – 7 (highest).

```
HP6208-A(config-vlan-2)#  
HP6208-A(config-vlan-2)# priority high  
HP6208-A(config-vlan-2)#
```

4. Enter the following commands to exit the VLAN CONFIG mode and save the configuration to the system-config file on flash memory:

```
HP6208-A(config-vlan-2)#  
HP6208-A(config-vlan-2)# end  
HP6208-A# write memory  
HP6208-A#
```

5. Repeat steps 1 – 4 on 6208M-SX B.

Syntax: vlan <vlan-id> by port

Syntax: priority normal | high

Enable Spanning Tree on a VLAN

The spanning tree bridge and port parameters are configurable using one CLI command set at the Global Configuration Level of each Port-based VLAN. Suppose you wanted to enable the IEEE 802.1d STP across VLAN 3. To do so, use the following method.

NOTE: When port-based VLANs are not operating on the system, STP is set on a system-wide level at the global CONFIG level of the CLI.

USING THE CLI

1. Access the global CONFIG level of the CLI on 6208M-SX A by entering the following commands:

```
HP6208-A> enable
No password has been assigned yet...
HP6208-A# configure terminal
HP6208-A(config)#
```

2. Access the level of the CLI for configuring port-based VLAN 3 by entering the following command:

```
HP6208-A(config)#
HP6208-A(config)# vlan 3
HP6208-A(config-vlan-3)#
```

3. From VLAN 3's configuration level of the CLI, enter the following command to enable STP on all tagged and untagged ports associated with VLAN 3.

```
HP6208-B(config-vlan-3)#
HP6208-B(config-vlan-3)# spanning-tree
HP6208-B(config-vlan-3)#
```

4. Enter the following commands to exit the VLAN CONFIG mode and save the configuration to the system-config file on flash memory:

```
HP6208-B(config-vlan-3)#
HP6208-B(config-vlan-3)# end
HP6208-B# write memory
HP6208-B#
```

5. Repeat steps 1 – 4 on 6208M-SX B.

NOTE: You do not need to configure values for the STP parameters. All parameters have default values as noted below. Additionally, all values will be globally applied to all ports on the system or on the port-based VLAN for which they are defined.

To configure a specific path-cost or priority value for a given port, enter those values using the key words in the brackets [] shown in the syntax summary below. If you do not want to specify values for any given port, this portion of the command is not required.

Syntax: vlan <vlan-id> by port

Syntax: [no] spanning-tree

Syntax: spanning-tree [ethernet <portnum> path-cost <value> priority <value>] forward-delay <value> hello-time <value> maximum-age <time> priority <value>

Bridge STP Parameters (applied to all ports within a VLAN)

- Forward Delay – the period of time a bridge will wait (the listen and learn period) before forwarding data packets. Possible values: 4 – 30 seconds. Default is 15.
- Maximum Age – the interval a bridge will wait for receipt of a hello packet before initiating a topology change. Possible values: 6 – 40 seconds. Default is 20.
- Hello Time – the interval of time between each configuration BPDU sent by the root bridge. Possible values: 1 – 10 seconds. Default is 2.

- Priority – a parameter used to identify the root bridge in a network. The bridge with the lowest value has the highest priority and is the root. Possible values: 1 – 65,535. Default is 32,678.

Port Parameters (applied to a specified port within a VLAN)

- Path Cost – a parameter used to assign a higher or lower path cost to a port. Possible values: 1 – 65535. Default is (1000/Port Speed) for Half-Duplex ports and is (1000/Port Speed)/2 for Full-Duplex ports.
- Priority – value determines when a port will be rerouted in relation to other ports. Possible values: 0 – 255. Default is 128.

Configuring IP Sub-net, IPX Network and Protocol-Based VLANs

Protocol-based VLANs provide the ability to define separate broadcast domains for several unique Layer 3 protocols within a single Layer 2 broadcast domain. Some applications for this feature might include security between departments with unique protocol requirements. This feature enables you to limit the amount of broadcast traffic end-stations, servers, and routers need to accept.

NOTE: See “Configuring AppleTalk Cable VLANs” on page 13-29 for information about configuring an AppleTalk cable VLAN.

Example: Suppose you want to create four separate Layer 3 broadcast domains within a single Layer 2 STP broadcast domain:

- Two broadcast domains, one for each of two separate IP sub-nets
- One for IPX Network 1
- One for the Appletalk protocol

Also suppose you want a single router interface to be present within all of these separate broadcast domains, without using IEEE 802.1p VLAN tagging or any proprietary form of VLAN tagging.

Figure 13.11 shows this configuration.

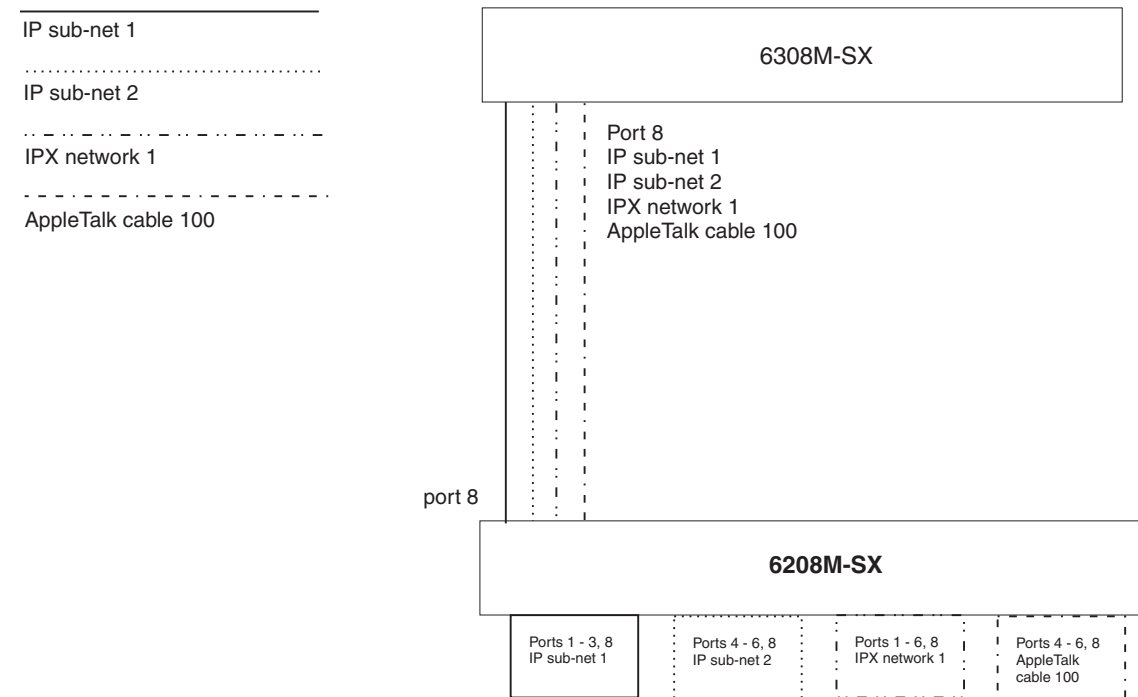

Figure 13.11 Protocol-based (Layer 3) VLANs

To configure the VLANs shown in Figure 13.11, use the following procedure.

USING THE CLI

1. To permanently assign ports 1 – 3 and port 8 to IP sub-net VLAN 1.1.1.0, enter the following commands

```
HP6208> en
No password has been assigned yet...
HP6208# config t
HP6208(config)#
HP6208(config)# ip-subnet 1.1.1.0/24 name Green
HP6208(config-ip-subnet)# no dynamic
HP6208(config-ip-subnet)# static ethernet 1 to 3 ethernet 8
```

2. To permanently assign ports 4 – 6 and port 8 to IP sub-net VLAN 1.1.2.0, enter the following commands:

```
HP6208(config-ip-subnet)# ip-subnet 1.1.2.0/24 name Yellow
HP6208(config-ip-subnet)# no dynamic
HP6208(config-ip-subnet)# static ethernet 4 to 6 ethernet 8
```

3. To permanently assign ports 1 – 6 and port 8 to IPX network 1 VLAN, enter the following commands:

```
HP6208(config-ip-subnet)# ipx-network 1 ethernet_802.3 name Blue
HP6208(config-ipx-network)# no dynamic
HP6208(config-ipx-network)# static ethernet 1 to 6 ethernet 8
HP6208(config-ipx-network)#
```

4. To permanently assign ports 4 – 6 and port 8 to Appletalk VLAN, enter the following commands:

```
HP6208(config-ipx-PROTO)# atalk-PROTO name Red
HP6208(config-ATALK-PROTO)# no dynamic
HP6208(config-ATALK-PROTO)# static ethernet 4 to 6 ethernet 8
HP6208(config-ATALK-PROTO)# end
HP6208# write memory
HP6208#
```

Syntax: ip-subnet <ip-addr> <ip-mask> [name <string>]

Syntax: ipx-network <ipx-network-number> <frame-encapsulation-type> netbios-allow | netbios-disallow
[name <string>]

Syntax: ip-PROTO | ipx-PROTO | atalk-PROTO | decnet-PROTO | netbios-PROTO | other-PROTO
static | exclude | dynamic
ethernet <portnum> [to <portnum>] [name <string>]

Routing Between VLANs using Virtual Interfaces (Routing Switches Only)

The routing switches offer the ability to create a virtual interface within a Layer 2 STP port-based VLAN or within each Layer 3 protocol, IP sub-net, or IPX network VLAN. This combination of multiple Layer 2 and/or Layer 3 broadcast domains and virtual interfaces are the basis for Integrated Switch Routing (ISR). ISR is very flexible and can solve many networking problems. The following example is meant to provide ideas by demonstrating some of the concepts of ISR.

Example: Suppose you want to move routing out to each of three buildings in a network. Remember that the only protocols present on VLAN 2 and VLAN 3 are IP and IPX. Therefore, you can eliminate tagged ports 25 and 26 from both VLAN 2 and VLAN 3 and create new tagged port-based VLANs to support separate IP sub-nets and IPX networks for each backbone link.

You also need to create unique IP sub-nets and IPX networks within VLAN 2 and VLAN 3 at each building. This will create a fully routed IP and IPX backbone for VLAN 2 and VLAN 3. However, VLAN 4 has no protocol restrictions across the backbone. In fact there are requirements for NetBIOS and DecNet to be bridged among the three building locations. The IP sub-net and IPX network that exists within VLAN 4 must remain a flat Layer 2 switched STP domain. You enable routing for IP and IPX on a virtual interface only on 9304 A. This will provide

the flat IP and IPX segment with connectivity to the rest of the network. Within VLAN 4 IP and IPX will follow the STP topology. All other IP sub-nets and IPX networks will be fully routed and have use of all paths at all times during normal operation.

Figure 13.12 shows the configuration described above.

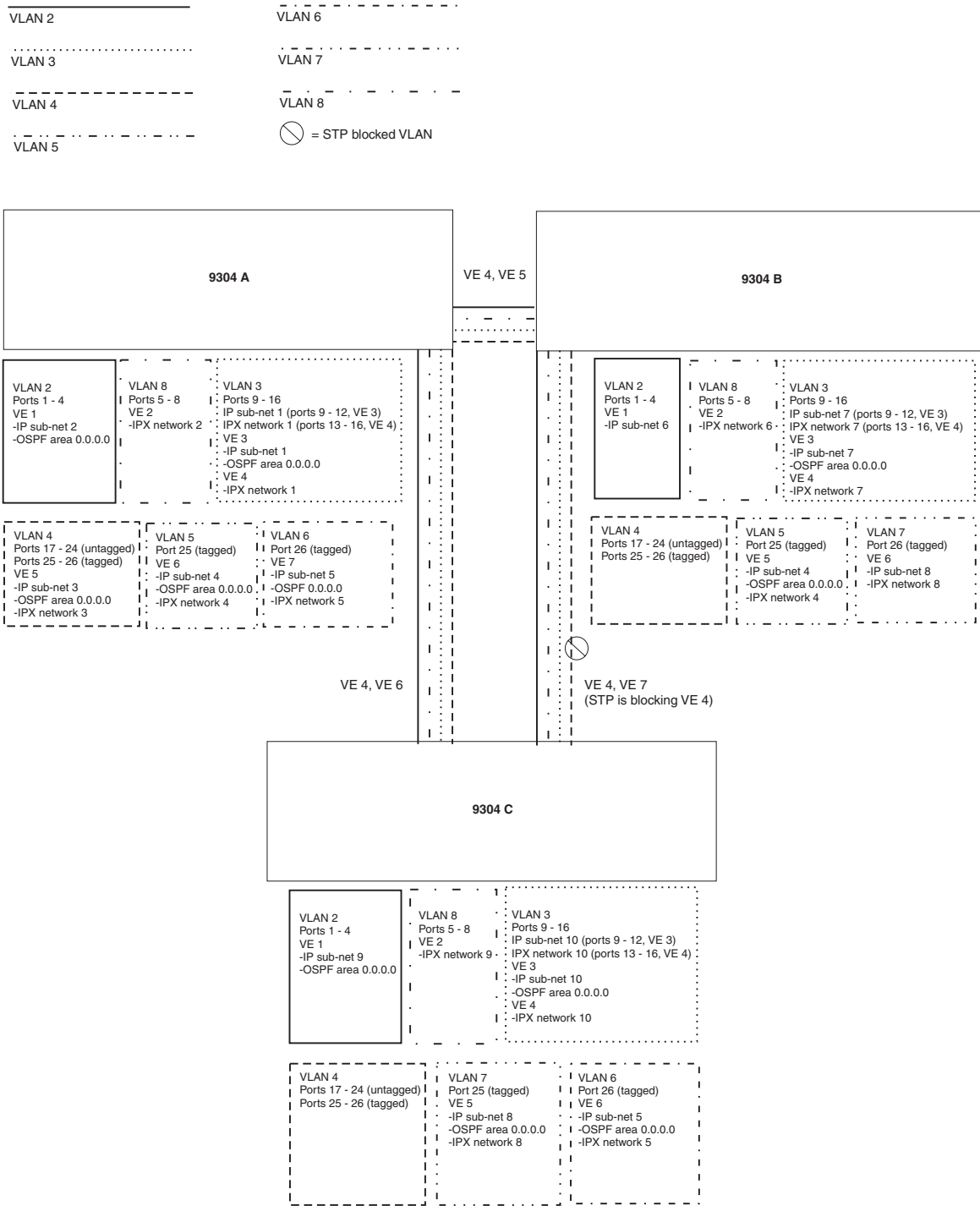

Figure 13.12 Routing between protocol-based VLANs

To configure the Layer 3 VLANs and virtual interfaces on the routing switches in Figure 13.12, use the following procedure.

USING THE CLI

Configuring 9304 A

Enter the following commands to configure 9304 A. The following commands enable OSPF or RIP routing and IPX routing.

```
HP9300> en
No password has been assigned yet...
HP9300# configure terminal
HP9300(config)# hostname HP9300-A
HP9300-A(config)# router ospf
HP9300-A(config-ospf-router)# area 0.0.0.0 normal
HP9300-A(config-ospf-router)# router ipx
ipx routing enabled for next power cycle.
Please save configuration to flash and reboot.
HP9300-A(config-ospf-router)#
```

The following commands create the port-based VLAN 2. In the previous example, an HP 9304M defined the router interfaces for VLAN 2. With ISR, routing for VLAN 2 is done locally within each HP 9304M. Therefore, there are two ways you can solve this problem. One way is to create a unique IP sub-net and IPX network VLAN, each with its own virtual interface and unique IP or IPX address within VLAN 2 on each HP 9304M. In this example, this is the configuration used for VLAN 3. The second way is to split VLAN 2 into two separate port-based VLANs and create a virtual interface within each port-based VLAN. Later in this example, this second option is used to create a port-based VLAN 8 to show that there are multiple ways to accomplish the same task with ISR.

You also need to create the Other-Protocol VLAN within port-based VLAN 2 and 8 to prevent unwanted protocols from being Layer 2 switched within port-based VLAN 2 or 8. Note that the only port-based VLAN that requires STP in this example is VLAN 4. You will need to configure the rest of the network to prevent the need to run STP.

```
HP9300-A(config-ospf-router)# vlan 2 name IP-Subnet_1.1.2.0/24
HP9300-A(config-vlan-2)# untag e1/1 to 1/4
HP9300-A(config-vlan-2)# no spanning-tree
HP9300-A(config-vlan-2)# router-interface ve1
HP9300-A(config-vlan-2)# other-proto name block_other_protocols
HP9300-A(config-vlan-other-proto)# no dynamic
HP9300-A(config-vlan-other-proto)# exclude e1/1 to 1/4
```

Once you have defined the port-based VLAN and created the virtual interface, you need to configure the virtual interface just as you would configure a physical interface.

```
HP9300-A(config-vlan-other-proto)# interface ve1
HP9300-A(config-vif-1)# ip address 1.1.2.1/24
HP9300-A(config-vif-1)# ip ospf area 0.0.0.0
```

Do the same thing for VLAN 8.

```
HP9300-A(config-vif-1)# vlan 8 name IPX_Network2
HP9300-A(config-vlan-8)# untag ethernet 1/5 to 1/8
HP9300-A(config-vlan-8)# no spanning-tree
HP9300-A(config-vlan-8)# router-interface ve 2
HP9300-A(config-vlan-8)# other-proto name block-other-protocols
HP9300-A(config-vlan-other-proto)# no dynamic
HP9300-A(config-vlan-other-proto)# exclude ethernet 1/5 to 1/8
HP9300-A(config-vlan-other-proto)# int ve2
HP9300-A(config-vif-2)# ipx network 2 ethernet_802.3
HP9300-A(config-vif-2)#
```

The next thing you need to do is create VLAN 3. This is very similar to the previous example with the addition of virtual interfaces to the IP sub-net and IPX network VLANs. Also there is no need to exclude ports from the IP sub-net and IPX network VLANs on the routing switch.

```
HP9300-A(config-vif-2)# vlan 3 name IP_Sub_&_IPX_Net_VLAN
HP9300-A(config-vlan-3)# untag e2/1 to 2/8
HP9300-A(config-vlan-3)# no spanning-tree
HP9300-A(config-vlan-3)# ip-subnet 1.1.1.0/24
HP9300-A(config-vlan-ip-subnet)# static e2/1 to 2/4
HP9300-A(config-vlan-ip-subnet)# router-interface ve3
HP9300-A(config-vlan-ip-subnet)# ipx-network 1 ethernet_802.3
HP9300-A(config-vlan-ipx-network)# static e2/5 to 2/8
HP9300-A(config-vlan-ipx-network)# router-interface ve4
HP9300-A(config-vlan-ipx-network)# other-proto name block-other-protocols
HP9300-A(config-vlan-other-proto)# exclude e2/1 to 2/8
HP9300-A(config-vlan-other-proto)# no dynamic
HP9300-A(config-vlan-other-proto)# interface ve 3
HP9300-A(config-vif-3)# ip addr 1.1.1.1/24
HP9300-A(config-vif-3)# ip ospf area 0.0.0.0
HP9300-A(config-vif-3)# int ve4
HP9300-A(config-vif-4)# ipx network 1 ethernet_802.3
HP9300-A(config-vif-4)#
```

Now configure VLAN 4. Remember this is a flat segment that, in the previous example, obtained its IP default gateway and IPX router services from an external HP 9304M. In this example, 9304 A will provide the routing services for VLAN 4. You also want to configure the STP priority for VLAN 4 to make 9304 A the root bridge for this VLAN.

```
HP9300-A(config-vif-4)# vlan 4 name Bridged_ALL_Protocols
HP9300-A(config-vlan-4)# untag ethernet 3/1 to 3/8
```

```

HP9300-A(config-vlan-4)# tag ethernet 4/1 to 4/2
HP9300-A(config-vlan-4)# spanning-tree
HP9300-A(config-vlan-4)# spanning-tree priority 500
HP9300-A(config-vlan-4)# router-interface ve5
HP9300-A(config-vlan-4)# int ve5
HP9300-A(config-vif-5)# ip address 1.1.3.1/24
HP9300-A(config-vif-5)# ip ospf area 0.0.0.0
HP9300-A(config-vif-5)# ipx network 3 ethernet_802.3
HP9300-A(config-vif-5)#

```

It is time to configure a separate port-based VLAN for each of the routed backbone ports (Ethernet 25 and 26). If you do not create a separate tagged port-based VLAN for each point-to-point backbone link, you need to include tagged interfaces for Ethernet 25 and 26 within VLANs 2, 3, and 8. This type of configuration makes the entire backbone a single STP domain for each VLAN 2, 3, and 8. This is the configuration used in the example in “Configuring IP Sub-net, IPX Network and Protocol-Based VLANs” on page 13-20. In this scenario, the virtual interfaces within port-based VLANs 2, 3, and 8 will be accessible using only one path through the network. The path that is blocked by STP is not available to the routing protocols until it is in the STP FORWARDING state.

```

HP9300-A(config-vif-5)# vlan 5 name Rtr_BB_to_Bldg.2
HP9300-A(config-vlan-5)# tag e4/1
HP9300-A(config-vlan-5)# no spanning-tree
HP9300-A(config-vlan-5)# router-interface ve6
HP9300-A(config-vlan-5)# vlan 6 name Rtr_BB_to_Bldg.3
HP9300-A(config-vlan-6)# tag ethernet 4/2
HP9300-A(config-vlan-6)# no spanning-tree
HP9300-A(config-vlan-6)# router-interface ve7
HP9300-A(config-vlan-6)# int ve6
HP9300-A(config-vif-6)# ip addr 1.1.4.1/24
HP9300-A(config-vif-6)# ip ospf area 0.0.0.0
HP9300-A(config-vif-6)# ipx network 4 ethernet_802.3
HP9300-A(config-vif-6)# int ve7
HP9300-A(config-vif-7)# ip addr 1.1.5.1/24
HP9300-A(config-vif-7)# ip ospf area 0.0.0.0
HP9300-A(config-vif-7)# ipx network 5 ethernet_802.3
HP9300-A(config-vif-7)#

```

This completes the configuration for 9304 A. The configuration for 9304 B and C is very similar except for a few issues.

- IP sub-nets and IPX networks configured on 9304 B and 9304 C must be unique across the entire network, except for the backbone port-based VLANs 5, 6, and 7 where the sub-net is the same but the IP address must change.
- There is no need to change the default priority of STP within VLAN 4.

- There is no need to include a virtual interface within VLAN 4.
- The backbone VLAN between 9304 B and 9304 C must be the same at both ends and requires a new VLAN ID. The VLAN ID for this port-based VLAN is VLAN 7.

Configuration for 9304 B

Enter the following commands to configure 9304 B.

```
HP9300> en
No password has been assigned yet...
HP9300# config t
HP9300(config)# hostname HP9300-B
HP9300-B(config)# router ospf
HP9300-B(config-ospf-router)# area 0.0.0.0 normal
HP9300-B(config-ospf-router)# router ipx
HP9300-B(config-ospf-router)# vlan 2 name IP-Subnet_1.1.6.0/24
HP9300-B(config-vlan-2)# untag e1/1 to 1/4
HP9300-B(config-vlan-2)# no spanning-tree
HP9300-B(config-vlan-2)# router-interface ve1
HP9300-B(config-vlan-2)# other-proto name block-other-protocols
HP9300-B(config-vlan-other-proto)# no dynamic
HP9300-B(config-vlan-other-proto)# exclude e1/1 to 1/4
HP9300-B(config-vlan-other-proto)# int ve1
HP9300-B(config-vif-1)# ip addr 1.1.6.1/24
HP9300-B(config-vif-1)# ip ospf area 0.0.0.0
HP9300-B(config-vif-1)# vlan 8 name IPX_Network6
HP9300-B(config-vlan-8)# untag e 1/5 to 1/8
HP9300-B(config-vlan-8)# no span
HP9300-B(config-vlan-8)# router-int ve2
HP9300-B(config-vlan-8)# other-proto name block-other-protocols
HP9300-B(config-vlan-other-proto)# no dynamic
HP9300-B(config-vlan-other-proto)# exclude e1/5 to 1/8
HP9300-B(config-vlan-other-proto)# int ve2
HP9300-B(config-vif-2)# ipx net 6 ethernet_802.3
HP9300-B(config-vif-2)# vlan 3 name IP_Sub_&_IPX_Net_VLAN
HP9300-B(config-vlan-3)# untag e2/1 to 2/8
HP9300-B(config-vlan-3)# no spanning-tree
HP9300-B(config-vlan-3)# ip-subnet 1.1.7.0/24
HP9300-B(config-vlan-ip-subnet)# static e2/1 to 2/4
HP9300-B(config-vlan-ip-subnet)# router-interface ve3
HP9300-B(config-vlan-ip-subnet)# ipx-network 7 ethernet_802.3
```

```
HP9300-B(config-vlan-ipx-network)# static e2/5 to 2/8
HP9300-B(config-vlan-ipx-network)# router-interface ve4
HP9300-B(config-vlan-ipx-network)# other-proto name block-other-protocols
HP9300-B(config-vlan-other-proto)# exclude e2/1 to 2/8
HP9300-B(config-vlan-other-proto)# no dynamic
HP9300-B(config-vlan-other-proto)# interface ve 3
HP9300-B(config-vif-3)# ip addr 1.1.7.1/24
HP9300-B(config-vif-3)# ip ospf area 0.0.0.0
HP9300-B(config-vif-3)# int ve4
HP9300-B(config-vif-4)# ipx network 7 ethernet_802.3
HP9300-B(config-vif-4)# vlan 4 name Bridged_ALL_Protocols
HP9300-B(config-vlan-4)# untag ethernet 3/1 to 3/8
HP9300-B(config-vlan-4)# tag ethernet 4/1 to 4/2
HP9300-B(config-vlan-4)# spanning-tree
HP9300-B(config-vlan-4)# vlan 5 name Rtr_BB_to_Bldg.1
HP9300-B(config-vlan-5)# tag e4/1
HP9300-B(config-vlan-5)# no spanning-tree
HP9300-B(config-vlan-5)# router-interface ve5
HP9300-B(config-vlan-5)# vlan 7 name Rtr_BB_to_Bldg.3
HP9300-B(config-vlan-7)# tag ethernet 4/2
HP9300-B(config-vlan-7)# no spanning-tree
HP9300-B(config-vlan-7)# router-interface ve6
HP9300-B(config-vlan-7)# int ve5
HP9300-B(config-vif-5)# ip addr 1.1.4.2/24
HP9300-B(config-vif-5)# ip ospf area 0.0.0.0
HP9300-B(config-vif-5)# ipx network 4 ethernet_802.3
HP9300-B(config-vif-5)# int ve6
HP9300-B(config-vif-6)# ip addr 1.1.8.1/24
HP9300-B(config-vif-6)# ip ospf area 0.0.0.0
HP9300-B(config-vif-6)# ipx network 8 ethernet_802.3
HP9300-B(config-vif-6)#
```

Configuration for 9304 C

Enter the following commands to configure 9304 C.

```
HP9300> en
No password has been assigned yet...
HP9300# config t
HP9300(config)# hostname HP9300-C
HP9300-C(config)# router ospf
```

```
HP9300-C(config-ospf-router)# area 0.0.0.0 normal
HP9300-C(config-ospf-router)# router ipx
HP9300-C(config-ospf-router)# vlan 2 name IP-Subnet_1.1.9.0/24
HP9300-C(config-vlan-2)# untag e1/1 to 1/4
HP9300-C(config-vlan-2)# no spanning-tree
HP9300-C(config-vlan-2)# router-interface ve1
HP9300-C(config-vlan-2)# other-proto name block-other-protocols
HP9300-C(config-vlan-other-proto)# no dynamic
HP9300-C(config-vlan-other-proto)# exclude e1/1 to 1/4
HP9300-C(config-vlan-other-proto)# int ve1
HP9300-C(config-vif-1)# ip addr 1.1.9.1/24
HP9300-C(config-vif-1)# ip ospf area 0.0.0.0
HP9300-C(config-vif-1)# vlan 8 name IPX_Network9
HP9300-C(config-vlan-8)# untag e 1/5 to 1/8
HP9300-C(config-vlan-8)# no span
HP9300-C(config-vlan-8)# router-int ve2
HP9300-C(config-vlan-8)# other-proto name block-other-protocols
HP9300-C(config-vlan-other-proto)# no dynamic
HP9300-C(config-vlan-other-proto)# exclude e1/5 to 1/8
HP9300-C(config-vlan-other-proto)# int ve2
HP9300-C(config-vif-2)# ipx net 9 ethernet_802.3
HP9300-C(config-vif-2)# vlan 3 name IP_Sub_&_IPX_Net_VLAN
HP9300-C(config-vlan-3)# untag e2/1 to 2/8
HP9300-C(config-vlan-3)# no spanning-tree
HP9300-C(config-vlan-3)# ip-subnet 1.1.10.0/24
HP9300-C(config-vlan-ip-subnet)# static e2/1 to 2/4
HP9300-C(config-vlan-ip-subnet)# router-interface ve3
HP9300-C(config-vlan-ip-subnet)# ipx-network 10 ethernet_802.3
HP9300-C(config-vlan-ipx-network)# static e2/5 to 2/8
HP9300-C(config-vlan-ipx-network)# router-interface ve4
HP9300-C(config-vlan-ipx-network)# other-proto name block-other-protocols
HP9300-C(config-vlan-other-proto)# exclude e2/1 to 2/8
HP9300-C(config-vlan-other-proto)# no dynamic
HP9300-C(config-vlan-other-proto)# interface ve 3
HP9300-C(config-vif-3)# ip addr 1.1.10.1/24
HP9300-C(config-vif-3)# ip ospf area 0.0.0.0
HP9300-C(config-vif-3)# int ve4
HP9300-C(config-vif-4)# ipx network 10 ethernet_802.3
```

```
HP9300-C(config-vif-4)# vlan 4 name Bridged_ALL_Protocols
HP9300-C(config-vlan-4)# untag ethernet 3/1 to 3/8
HP9300-C(config-vlan-4)# tag ethernet 4/1 to 4/2
HP9300-C(config-vlan-4)# spanning-tree
HP9300-C(config-vlan-4)# vlan 7 name Rtr_BB_to_Bldg.2
HP9300-C(config-vlan-7)# tag e4/1
HP9300-C(config-vlan-7)# no spanning-tree
HP9300-C(config-vlan-7)# router-interface ve5
HP9300-C(config-vlan-7)# vlan 6 name Rtr_BB_to_Bldg.3
HP9300-C(config-vlan-6)# tag ethernet 4/2
HP9300-C(config-vlan-6)# no spanning-tree
HP9300-C(config-vlan-6)# router-interface ve6
HP9300-C(config-vlan-6)# int ve5
HP9300-C(config-vif-5)# ip addr 1.1.8.2/24
HP9300-C(config-vif-5)# ip ospf area 0.0.0.0
HP9300-C(config-vif-5)# ipx network 8 ethernet_802.3
HP9300-C(config-vif-5)# int ve6
HP9300-C(config-vif-6)# ip addr 1.1.5.2/24
HP9300-C(config-vif-6)# ip ospf area 0.0.0.0
HP9300-C(config-vif-6)# ipx network 5 ethernet_802.3
HP9300-C(config-vif-6)#
```

Configuring AppleTalk Cable VLANs

You can configure up to eight AppleTalk cable VLANs within a port-based VLAN.

To configure an AppleTalk cable VLAN, you create a port-based VLAN, then create up to eight cable VLANs within the port-based VLAN. You create the AppleTalk cable VLAN by assigning a number to the VLAN, optionally naming the cable VLAN, assigning ports from the port-based VLAN, and specifying the router interface (virtual interface) on which the routing switch will send and receive traffic for the cable VLAN.

All the ports in an AppleTalk cable VLAN are within the same AppleTalk cable range. The routing switch switches traffic within the VLAN and routes traffic between VLANs.

Configuration Guidelines

Use the following guidelines when configuring AppleTalk cable VLANs:

- Up to eight AppleTalk cable VLANs are supported in a protocol-based VLAN. Each VLAN must be numbered from 1 – 8.
- Each AppleTalk cable VLAN can have only one router interface. The router interface must be a virtual interface.
- The AppleTalk cable VLANs cannot overlap. Thus, you cannot use the same port in more than one AppleTalk cable VLAN.
- You must add the ports to the AppleTalk cable VLAN using the static option. You cannot use the dynamic or exclude options.

- You cannot have an AppleTalk cable VLAN and an AppleTalk protocol VLAN in the same port-based VLAN. If you already have an AppleTalk protocol VLAN in the port-based VLAN, you must delete the AppleTalk protocol VLAN first, then configure the AppleTalk cable VLAN.

Configuration Example

Figure 3 shows an example of an HP 9308M routing switch with four AppleTalk cable VLANs configured on a single port-based VLAN. In this example, port-based VLAN 10 is configured, then AppleTalk cable VLANs are configured on ports on chassis modules 2 and 3. Each virtual interface (ve1, ve2, ve3, and ve4) is then configured with AppleTalk routing information for the cable VLAN.

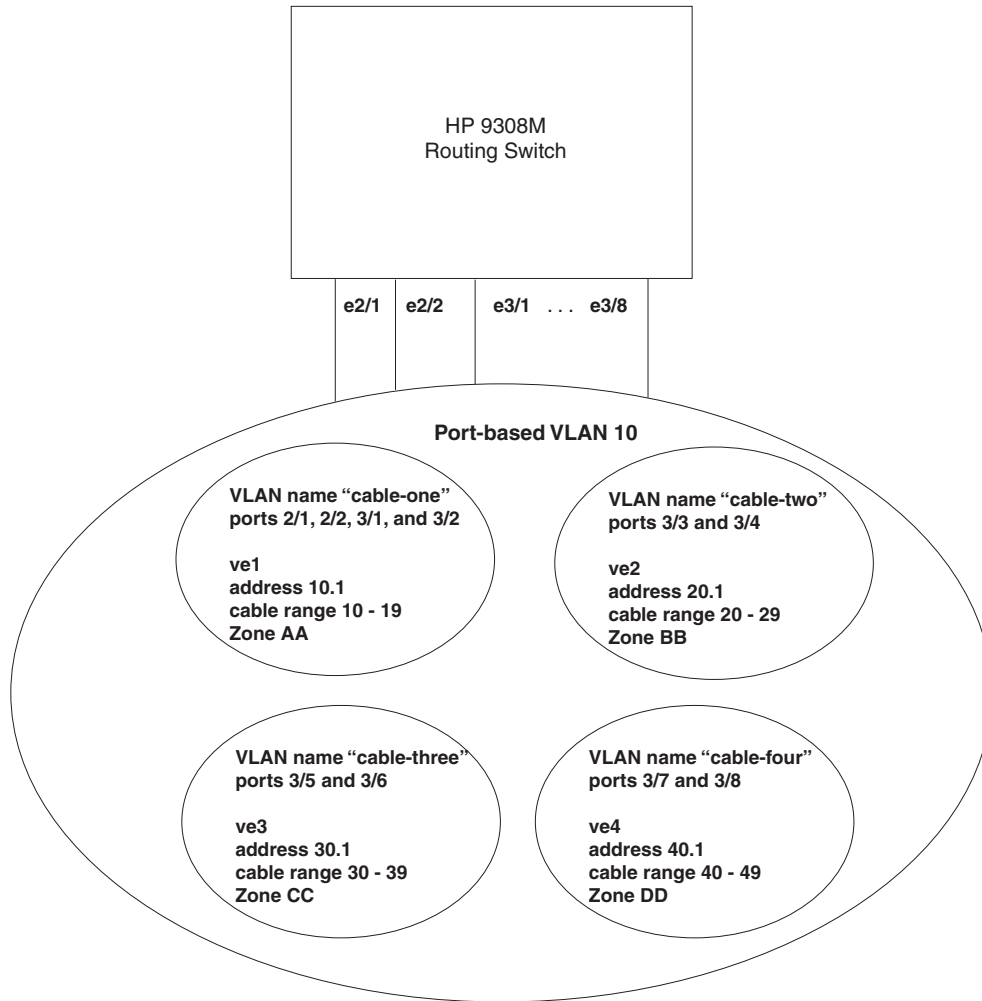

Figure 13.13 AppleTalk Cable VLANs

Configuring the VLANs

To configure the VLANs shown in Figure 3, enter the following CLI commands:

```
HP9300(config)# vlan 10 by port
HP9300(config-vlan-10)# untag ethe 2/1 to 2/2 ethe 3/1 to 3/8
```

The two commands above add port-based VLAN 10 and add ports 2/1, 2/2, and 3/1 – 3/16 to the VLAN. The **untag** command removes ports from the default VLAN and adds them to port-based VLAN 10. (The default VLAN contains all the ports in the system by default.) The **untag** command also allows the ports to process packets that do not contain 802.1p tagging.

The following commands add four AppleTalk cable VLANs, in groups of three commands each. The **appletalk-cable-vlan** command adds a cable VLAN and, with the optional **name** parameter, names the VLAN. The **static** command adds specific ports within the port-based VLAN to the AppleTalk cable VLAN. The **router-interface** command identifies virtual interface that connects to the AppleTalk cable range the VLAN is for.

```
HP9300(config-vlan-10)# appletalk-cable-vlan 1 name cable-one
HP9300(config-vlan-10)# static ethe 2/1 to 2/2 ethe 3/1 to 3/2
HP9300(config-vlan-10)# router-interface ve 1
HP9300(config-vlan-10)# appletalk-cable-vlan 2 name cable-two
HP9300(config-vlan-10)# static ethe 3/3 to 3/4
HP9300(config-vlan-10)# router-interface ve 2
HP9300(config-vlan-10)# appletalk-cable-vlan 3 name cable-three
HP9300(config-vlan-10)# static ethe 3/5 to 3/6
HP9300(config-vlan-10)# router-interface ve 3
HP9300(config-vlan-10)# appletalk-cable-vlan 4 name cable-four
HP9300(config-vlan-10)# static ethe 3/7 to 3/8
HP9300(config-vlan-10)# router-interface ve 4
```

Syntax: appletalk-cable-vlan <vlan-id> [name <string>]

The <vlan-id> can be from 1 – 8.

The **name** <string> parameter specifies a name and can be a string up to 32 characters long.

Configuring the Router Interfaces

The following commands configure the router interfaces (virtual interfaces) associated with the AppleTalk cable VLANs. The **interface ve** commands add the virtual interfaces to the system. (The **router-interface** commands above refer to these interfaces but do not add them. You must add the interfaces using the **interface ve** command.)

For each virtual interface, additional commands configure the AppleTalk routing parameters for the interface. Notice that each virtual interface has a separate set of routing parameters. The routing parameters on each virtual interface are independent of the routing parameters on other virtual interfaces. Since each AppleTalk cable VLAN is associated with a separate virtual interface, each AppleTalk cable VLAN has a distinct set of routing parameters, separate from the routing parameters on other AppleTalk VLANs. In effect, each virtual interface contains a separate AppleTalk routing switch.

The **appletalk address** command configures the AppleTalk interface address on the virtual interface. The **appletalk cable-range** command specifies the cable range for the network. The **appletalk routing** command enables AppleTalk routing on the virtual interface. The **zone-name** commands add zones to the network. For information about the AppleTalk routing commands, see the “Configuring AppleTalk” on page 12-1.

The **write memory** command at the end of the example saves the configuration to the startup-config file.

```
HP9300(config-vlan-10)# interface ve 1
HP9300(config-vif-1)# appletalk cable-range 10 - 19
HP9300(config-vif-1)# appletalk address 10.1
HP9300(config-vif-1)# appletalk zone-name AA
HP9300(config-vif-1)# appletalk routing
HP9300(config-vif-1)# interface ve 2
HP9300(config-vif-2)# appletalk cable-range 20 - 29
HP9300(config-vif-2)# appletalk address 20.1
```

```
HP9300 (config-vif-2)# appletalk zone-name BB
HP9300 (config-vif-2)# appletalk routing
HP9300 (config-vif-2)# interface ve 3
HP9300 (config-vif-3)# appletalk cable-range 30 - 39
HP9300 (config-vif-3)# appletalk address 30.1
HP9300 (config-vif-3)# appletalk zone-name CC
HP9300 (config-vif-3)# appletalk routing
HP9300 (config-vif-3)# interface ve 4
HP9300 (config-vif-4)# appletalk cable-range 40 - 49
HP9300 (config-vif-4)# appletalk address 40.1
HP9300 (config-vif-4)# appletalk zone-name DD
HP9300 (config-vif-4)# appletalk routing
HP9300 (config-vif-4)# write memory
```

Configuring Protocol VLANs With Dynamic Ports

The configuration examples for protocol VLANs in the sections above show how to configure the VLANs using static ports. You also can configure the following types of protocol VLANs with dynamic ports:

- AppleTalk protocol
- IP protocol
- IPX protocol
- IP sub-net
- IPX network

NOTE: The software does not support dynamically adding ports to AppleTalk cable VLANs. Conceptually, an AppleTalk cable VLAN comprises a single network cable, connected to a single port. Therefore, dynamic addition and removal of ports is not applicable.

NOTE: You cannot route to or from protocol VLANs with dynamically added ports.

Aging of Dynamic Ports

When you add the ports to the VLAN, the software automatically adds them all to the VLAN. However, dynamically added ports age out. If the age time for a dynamic port expires, the software removes the port from the VLAN. If that port receives traffic for the IP sub-net or IPX network, the software adds the port to the VLAN again and starts the aging timer over. Each time the port receives traffic for the VLAN's IP sub-net or IPX network, the aging timer starts over.

Dynamic ports within any protocol VLAN age out after 10 minutes, if no member protocol traffic is received on a port within the VLAN. The aged out port, however, remains as a candidate dynamic port for that VLAN. The port becomes active in the VLAN again if member protocol traffic is received on that port.

Once a port is re-activated, the aging out period for the port is reset to 20 minutes. Each time a member protocol packet is received by a candidate dynamic port (aged out port) the port becomes active again and the aging out period is reset for 20 minutes.

Configuration Guidelines

- You cannot dynamically add a port to a protocol VLAN if the port has any routing configuration parameters. For example, the port cannot have a virtual interface, IP sub-net address, IPX network address, or AppleTalk network address configured on it.
- Once you dynamically add a port to a protocol VLAN, you cannot configure routing parameters on the port.
- Dynamic VLAN ports are not required or supported on AppleTalk cable VLANs.

Configuring an IP, IPX, or AppleTalk Protocol VLAN with Dynamic Ports

To configure an IP, IPX, or AppleTalk protocol VLAN with dynamic ports, use one of the following methods.

USING THE CLI

To configure port-based VLAN 10, then configure an IP protocol VLAN within the port-based VLAN with dynamic ports, enter the following commands such as the following:

```
HP9300(config)# vlan 10 by port
HP9300(config-vlan-10)# untag ethernet 1/1 to 1/6
added untagged port ethe 1/1 to 1/6 to port-vlan 30.
HP9300(config-vlan-10)# ip-proto name IP_Prot_VLAN
HP9300(config-vlan-10)# dynamic
HP9300(config)# write memory
```

Syntax: vlan <vlan-id> by port [name <string>]

Syntax: untagged ethernet <portnum> to <portnum>

Or

Syntax: untagged ethernet <portnum> ethernet <portnum>

NOTE: Use the first **untagged** command for adding a range of ports. Use the second command for adding separate ports (not in a range).

Syntax: ip-proto [name <string>]

Syntax: ipx-proto [name <string>]

Syntax: appletalk-cable-vlan <num> [name <string>]

Syntax: dynamic

The procedure is similar for IPX and AppleTalk protocol VLANs. Enter **ipx-proto** or **atalk-proto** instead of **ip-proto**.

Configuring an IP Sub-Net VLAN with Dynamic Ports

To configure an IP sub-net VLAN with dynamic ports, use one of the following methods.

USING THE CLI

To configure port-based VLAN 10, then configure an IP sub-net VLAN within the port-based VLAN with dynamic ports, enter commands such as the following:

```
HP9300(config)# vlan 10 by port name IP_VLAN
HP9300(config-vlan-10)# untag ethernet 1/1 to 1/6
added untagged port ethe 1/1 to 1/6 to port-vlan 10.
HP9300(config-vlan-10)# ip-subnet 1.1.1.0/24 name Mktg-LAN
```

```
HP9300(config-vlan-10)# dynamic
```

```
HP9300(config)# write memory
```

These commands create a port-based VLAN on chassis ports 1/1 – 1/6 named “Mktg-LAN”, configure an IP subnet VLAN within the port-based VLAN, and then add ports from the port-based VLAN dynamically.

Syntax: vlan <vlan-id> by port [name <string>]

Syntax: untagged ethernet <portnum> to <portnum>

Or

Syntax: untagged ethernet <portnum> ethernet <portnum>

NOTE: Use the first **untagged** command for adding a range of ports. Use the second command for adding separate ports (not in a range).

Syntax: ip-subnet <ip-addr> <ip-mask> [name <string>]

Or

Syntax: ip-subnet <ip-addr>/<mask-bits> [name <string>]

Syntax: dynamic

Configuring an IPX Network VLAN with Dynamic Ports

To configure an IPX network VLAN with dynamic ports, use one of the following methods.

USING THE CLI

To configure port-based VLAN 20, then configure an IPX network VLAN within the port-based VLAN with dynamic ports, enter commands such as the following:

```
HP9300(config)# vlan 20 by port name IPX_VLAN
```

```
HP9300(config-vlan-10)# untag ethernet 2/1 to 2/6
```

```
added untagged port ethe 2/1 to 2/6 to port-vlan 20.
```

```
HP9300(config-vlan-10)# ipx-network abcd ethernet_ii name Eng-LAN
```

```
HP9300(config-vlan-10)# dynamic
```

```
HP9300(config)# write memory
```

These commands create a port-based VLAN on chassis ports 2/1 – 2/6 named “Eng-LAN”, configure an IPX network VLAN within the port-based VLAN, and then add ports from the port-based VLAN dynamically.

Syntax: vlan <vlan-id> by port [name <string>]

Syntax: untagged ethernet <portnum> to <portnum>

Or

Syntax: untagged ethernet <portnum> ethernet <portnum>

NOTE: Use the first **untagged** command for adding a range of ports. Use the second command for adding separate ports (not in a range).

Syntax: ipx-network <network-addr> ethernet_ii | ethernet_802.2 | ethernet_802.3 | ethernet_snap [name <string>]

Syntax: dynamic

Configuring the Same IP Sub-Net Address on Multiple Port-Based VLANs

For a device to route between port-based VLANs, you must add a virtual interface to each VLAN. Generally, you also configure a unique IP sub-net address on each virtual interface. For example, if you have three port-based VLANs, you add a virtual interface to each VLAN, then add a separate IP sub-net address to each virtual interface. The IP address on each of the virtual interfaces must be in a separate sub-net. The device routes Layer 3 traffic between the sub-nets using the sub-net addresses.

NOTE: This feature applies only to the HP 9304M, HP 9308M, and HP 6208M-SX routing switches.

Figure 13.14 shows an example of this type of configuration.

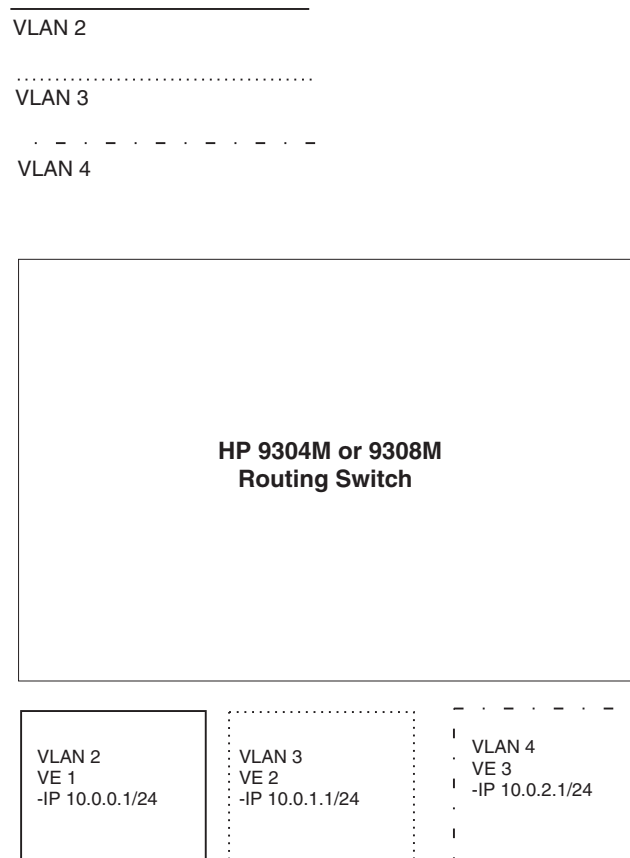

Figure 13.14 Multiple port-based VLANs with separate protocol addresses

As shown in this example, each VLAN has a separate IP sub-net address. If you need to conserve IP sub-net addresses, you can configure multiple VLANs with the same IP sub-net address, as shown in Figure 13.15.

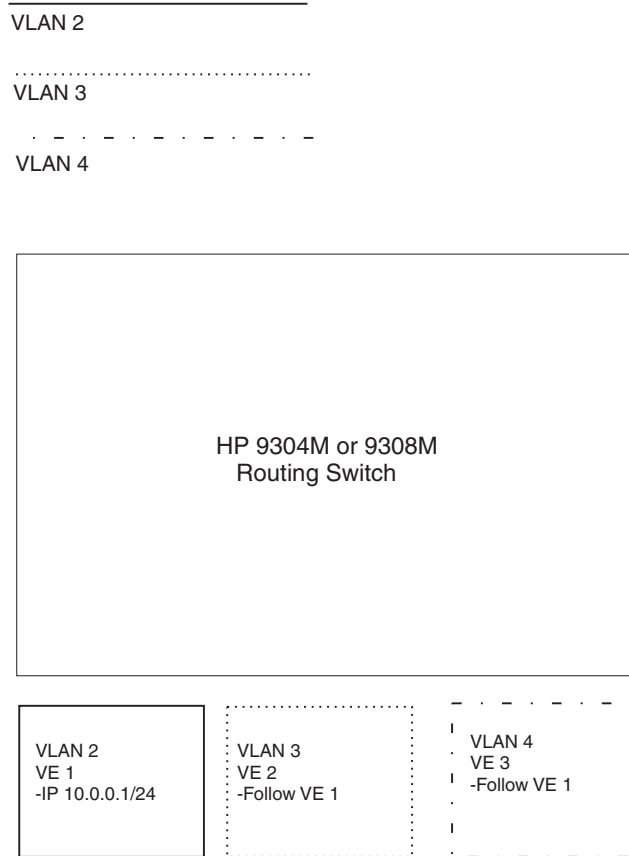

Figure 13.15 Multiple port-based VLANs with the same protocol address

Each VLAN still requires a separate virtual interface. However, all three VLANs now use the same IP sub-net address.

In addition to conserving IP sub-net addresses, this feature allows containment of Layer 2 broadcasts to segments within an IP sub-net. For ISP environments where the same IP sub-net is allocated to different customers, placing each customer in a separate VLAN allows all customers to share the IP sub-net address, while at the same time isolating them from one another's Layer 2 broadcasts.

NOTE: You can provide redundancy to an IP sub-net address that contains multiple VLANs using a pair of routing switches configured for VRRP (Virtual Router Redundancy Protocol) or SRP (Standby Router Protocol).

The device performs proxy Address Resolution Protocol (ARP) for hosts that want to send IP traffic to hosts in other VLANs that are sharing the same IP sub-net address. If the source and destination hosts are in the same VLAN, the device does not need to use ARP.

- If a host attached to one VLAN sends an ARP message for the MAC address of a host in one of the other VLANs using the same IP sub-net address, the device performs a proxy ARP on behalf of the other host. The device then replies to the ARP by sending the virtual interface MAC address. The device uses the same MAC address for all virtual interfaces.

When the host that sent the ARP then sends a unicast packet addressed to the virtual interface's MAC address, the routing switch switches the packet on Layer 3 to the destination host on the VLAN.

NOTE: If the device's ARP table does not contain the requested host, the device forwards the ARP request on Layer 2 to the same VLAN as the one that received the ARP request. Then the device sends an ARP for the destination to the other VLANs that are using the same IP sub-net address.

- If the destination is in the same VLAN as the source, the device does not need to perform a proxy ARP.

To configure multiple VLANs to use the same IP sub-net address:

- Configure each VLAN, including adding tagged or untagged ports.
- Configure a separate virtual interface for each VLAN, but do not add an IP sub-net address to more than one of the virtual interfaces.
- Configure the virtual interfaces that do not have the IP sub-net address to "follow" the virtual interface that does have the address.

USING THE CLI

To configure the VLANs shown in Figure 13.15, you could enter the following commands.

```
HP9300 (config)# vlan 1 by port
HP9300 (config-vlan-1)# untag ethernet 1/1
HP9300 (config-vlan-1)# tag ethernet 1/8
HP9300 (config-vlan-1)# router-interface ve 1
```

Syntax: ip follow ve <num>

The commands above configure port-based VLAN 1. The VLAN has one untagged port (1/1) and a tagged port (1/8). In this example, all three VLANs contain port 1/8 so the port must be tagged to allow the port to be in multiple VLANs. You can configure VLANs to share a Layer 3 protocol interface regardless of tagging. A combination of tagged and untagged ports is shown in this example to demonstrate that sharing the interface does not change other VLAN features.

Notice that each VLAN still requires a unique virtual interface.

The following CLI commands configure port-based VLANs 2 and 3.

```
HP9300 (config-vlan-1)# vlan 2 by port
HP9300 (config-vlan-2)# untag ethernet 1/2
HP9300 (config-vlan-2)# tag ethernet 1/8
HP9300 (config-vlan-2)# router-interface ve 2
HP9300 (config-vlan-2)# vlan 3 by port
HP9300 (config-vlan-3)# untag ethernet 1/5 to 1/6
HP9300 (config-vlan-3)# tag ethernet 1/8
HP9300 (config-vlan-3)# router-interface ve 3
```

The following commands configure an IP sub-net address on virtual interface 1.

```
HP9300 (config-vlan-3)# interface ve 1
HP9300 (config-vif-1)# ip address 10.0.0.1/24
```

The following commands configure virtual interfaces 2 and 3 to "follow" the IP sub-net address configured on virtual interface 1.

```
HP9300 (config-vif-1)# interface ve 2
HP9300 (config-vif-2)# ip follow ve 1
HP9300 (config-vif-2)# interface ve 3
HP9300 (config-vif-3)# ip follow ve 1
```

NOTE: Since virtual interfaces 2 and 3 do not have their own IP sub-net addresses but instead are “following” virtual interface 1’s IP address, you still can configure an IPX or AppleTalk interface on virtual interfaces 2 and 3.

Configuring VLANs Using the Web Management Interface

Use the procedures in the following sections to configure VLANs using the Web management interface.

Configuring a Port-Based VLAN

1. Log on to the device using a valid user name and password for read-write access.
2. If you have not already enabled OSPF, enable it by clicking on the Enable radio button next to OSPF on the System configuration dialog, then clicking Apply to apply the change.
3. Click on the plus sign next to Configure in the tree view to expand the list of configuration options.
4. Click on the plus sign next to VLAN in the tree view to expand the list of VLAN option links.
5. Click on the [Port](#) link.
 - If the device does not have any port-based VLANs, the Port VLAN configuration panel is displayed, as shown in the following example.
 - If at least one port-based VLAN is already configured and you are adding a new one, click on the [Add Port VLAN](#) link to display the Port VLAN configuration panel, as shown in the following example.
 - If you are modifying an existing port-based VLAN, click on the Modify button to the right of the row describing the VLAN to display the Port VLAN configuration panel, as shown in the following example.

Port VLAN

VLAN Id:	<input type="text" value="2"/>
Name:	<input type="text"/>
QoS:	<input type="text" value="0"/>
Spanning Tree	<input checked="" type="radio"/> Disable <input type="radio"/> Enable
Router Interface:	<input type="text" value="None"/>
Port members:	<input type="button" value="Select Port Members"/>

[\[Show\]\[Protocol VLAN\]](#)

[\[Home\]](#)
[\[Site Map\]](#)
[\[Logout\]](#)
[\[Save\]](#)
[\[Frame Enable\]](#)
[\[Disable\]](#)
[\[TELNET\]](#)

6. Enter the VLAN ID and optionally the name.
7. If you want to assign the VLAN to a different Quality of Service (QoS) priority, select the priority from the QoS field’s pulldown menu. For more information, see “Changing a Layer 2 Port-Based VLAN’s Priority” on page 2-12.
8. Select Enable to Disable next to Spanning Tree to enable or disable the feature on this VLAN.
9. Select the virtual interface (router interface) if applicable.

10. Click the Select Port Members button to display the following panel.

Port Members

Row 1 <input type="checkbox"/>	1/1 <input checked="" type="checkbox"/>	1/2 <input checked="" type="checkbox"/>	1/3 <input checked="" type="checkbox"/>	1/4 <input checked="" type="checkbox"/>	1/5 <input checked="" type="checkbox"/>	1/6 <input checked="" type="checkbox"/>	1/7 <input type="checkbox"/>	1/8 <input type="checkbox"/>
Row 2 <input type="checkbox"/>	3/1 <input type="checkbox"/>	3/2 <input type="checkbox"/>	3/3 <input type="checkbox"/>	3/4 <input type="checkbox"/>	3/5 <input type="checkbox"/>	3/6 <input type="checkbox"/>	3/7 <input type="checkbox"/>	3/8 <input type="checkbox"/>
Row 3 <input type="checkbox"/>	3/9 <input type="checkbox"/>	3/10 <input type="checkbox"/>	3/11 <input type="checkbox"/>	3/12 <input type="checkbox"/>	3/13 <input type="checkbox"/>	3/14 <input type="checkbox"/>	3/15 <input type="checkbox"/>	3/16 <input type="checkbox"/>
Row 4 <input type="checkbox"/>	3/17 <input type="checkbox"/>	3/18 <input type="checkbox"/>	3/19 <input type="checkbox"/>	3/20 <input type="checkbox"/>	3/21 <input type="checkbox"/>	3/22 <input type="checkbox"/>	3/23 <input type="checkbox"/>	3/24 <input type="checkbox"/>
Row 5 <input type="checkbox"/>	4/1 <input type="checkbox"/>	4/2 <input type="checkbox"/>	4/3 <input type="checkbox"/>	4/4 <input type="checkbox"/>	4/5 <input type="checkbox"/>	4/6 <input type="checkbox"/>	4/7 <input type="checkbox"/>	4/8 <input type="checkbox"/>
Row 6 <input type="checkbox"/>	4/9 <input type="checkbox"/>	4/10 <input type="checkbox"/>	4/11 <input type="checkbox"/>	4/12 <input type="checkbox"/>	4/13 <input type="checkbox"/>	4/14 <input type="checkbox"/>	4/15 <input type="checkbox"/>	4/16 <input type="checkbox"/>
Row 7 <input type="checkbox"/>	4/17 <input type="checkbox"/>	4/18 <input type="checkbox"/>	4/19 <input type="checkbox"/>	4/20 <input type="checkbox"/>	4/21 <input type="checkbox"/>	4/22 <input type="checkbox"/>	4/23 <input type="checkbox"/>	4/24 <input type="checkbox"/>

11. Select the ports you are placing in the VLAN. To select a row, click on the checkbox next to the row number, then click on the Select Row button.

NOTE: Ports highlighted in grey are members of a trunk group. The port right before the grey ports is the master port for that trunk group.

12. When you finish selecting the ports, click on the Continue button to return to the Port VLAN configuration dialog.
13. Click the Add button (to add a new VLAN) or the Modify button (if you are modifying an existing VLAN) to save the change to the device's running-config file.
14. Select the [Save](#) link at the bottom of the dialog, then select Yes when prompted to save the configuration change to the startup-config file on the device's flash memory.

NOTE: You also can access the dialog for saving configuration changes by clicking on Command in the tree view, then clicking on [Save to Flash](#).

Configuring a Protocol-Based VLAN

This procedure describes how to configure a protocol-based VLAN. To configure an IP sub-net VLAN, IPX network VLAN, or AppleTalk cable VLAN, see the sections following this one.

- Log on to the device using a valid user name and password for read-write access.
- Click on the plus sign next to Configure in the tree view to expand the list of configuration options.
- Click on the plus sign next to VLAN in the tree view to expand the list of VLAN option links.
- Click on the [Protocol](#) link.
 - If the device does not have any protocol VLANs, the Protocol VLAN configuration panel is displayed, as shown in the following example.
 - If at least one protocol VLAN is already configured and you are adding a new one, click on the [Protocol](#) link to display the Protocol VLAN configuration panel.
 - If you are modifying an existing protocol VLAN, click on the Modify button to the right of the row describing the VLAN to display the configuration panel for the type of VLAN you are modifying. The following example shows the Protocol VLAN configuration dialog, used for configuring a protocol VLAN (not an IP sub-net, IPX network, or AppleTalk cable VLAN).

VLAN Id:	1
VLAN Port_members:	1/7,1/8, 3/1,3/2,3/3,3/4,3/5,3/6,3/7,3/8, 3/9,3/10,3/11,3/12,3/13,3/14 3/15,3/16, 3/17,3/18,3/19,3/20,3/21,3/22,3/23,3/24, 4/1,4/2,4/3,4/4,4/5,4/6 4/7,4/8, 4/9,4/10,4/11,4/12,4/13,4/14,4/15,4/16, 4/17,4/18,4/19,4/20,4/21,4/22 4/23,4/24
Protocol_VLAN_Name:	
Router_Interface:	None
Protocol Type:	<input type="radio"/> IP <input type="radio"/> IPX <input type="radio"/> AppleTalk <input type="radio"/> Decnet <input type="radio"/> NetBIOS <input checked="" type="radio"/> Others
Selected Port Members:	<input type="checkbox"/> Dynamic Port Static Port: <input type="button" value="Change Static Members"/> Exclude Port: <input type="button" value="Change Exclude Members"/>

[\[Show\]](#)[\[Protocol\]](#)[\[IP Subnet\]](#)[\[IPX Network\]](#)[\[AppleTalk Cable\]](#)

[\[Home\]](#)[\[Site Map\]](#)[\[Logout\]](#)[\[Save\]](#)[\[Frame Enable\]](#)[\[Disable\]](#)[\[TELNET\]](#)

5. Enter the VLAN ID that will contain the protocol VLAN in the VLAN ID field.
6. Enter a name for the VLAN in the Protocol_VLAN_Name field.
7. Select the virtual interface from the Router_Interface pulldown list if you configured a virtual interface for routing into and out of the VLAN.
8. Select the protocol type.
9. Specify the port that are members for the VLAN:
 - Select Dynamic Port if you want the port membership to be dynamic. For information, see “Dynamic Ports” on page 13-9.
 - Click the Change Static Members button if you want to configure static ports. For information, see “Static Ports” on page 13-10.
 - Click the Change Exclude Members button if you want to explicitly exclude some ports. For information, see “Excluded Ports” on page 13-10.

NOTE: All the ports must be members of the port-based VLAN that contains this IP sub-net VLAN. See “Layer 3 Protocol-Based VLANs” on page 13-3.

10. Click the Add button (if you are adding a new VLAN) or the Modify button (if you are modifying an existing VLAN) to save the change to the device’s running-config file.
11. Select the [Save](#) link at the bottom of the dialog. Select Yes when prompted to save the configuration change to the startup-config file on the device’s flash memory.

NOTE: You also can access the dialog for saving configuration changes by clicking on Command in the tree view, then clicking on [Save to Flash](#).

Configuring an IP Sub-Net VLAN

- Log on to the device using a valid user name and password for read-write access.
- Click on the plus sign next to Configure in the tree view to expand the list of configuration options.
- Click on the plus sign next to VLAN in the tree view to expand the list of VLAN option links.
- Click on the [Protocol](#) link.
 - If the device does not have any protocol VLANs, the Protocol VLAN configuration panel is displayed, as shown in the following example.
 - If at least one protocol VLAN is already configured and you are adding a new one, click on the [IP Subnet](#) link to display the IP Sub-net Protocol VLAN configuration panel.
 - If you are modifying an existing protocol VLAN, click on the Modify button to the right of the row describing the VLAN to display the configuration panel for the type of VLAN you are modifying. The following example shows the IP Sub-net Protocol VLAN configuration dialog, used for configuring an IP sub-net protocol VLAN (not a protocol, IPX network, or AppleTalk cable VLAN)

VLAN Id:	2
VLAN Port members:	1/7,1/8, 3/1,3/2,3/3,3/4, 3/5,3/6,3/7,3/8, 3/9,3/10,3/11,3/12,3/13,3/14 3/15,3/16, 3/17,3/18,3/19,3/20,3/21,3/22,3/23,3/24, 4/1,4/2,4/3,4/4,4/5,4/6 4/7,4/8, 4/9,4/10,4/11,4/12,4/13,4/14,4/15,4/16, 4/17,4/18,4/19,4/20,4/21,4/22 4/23,4/24
Protocol_VLAN_Name:	
Router_Interface:	None
IP_Address:	209.157.22.4
Mask:	255.255.255.0
Selected Port Members:	<input type="checkbox"/> Dynamic Port Static Port: <input type="button" value="Change Static Members"/> Exclude Port: <input type="button" value="Change Exclude Members"/>

[\[Show\]](#)
[\[Protocol\]](#)
[\[IP Subnet\]](#)
[\[IPX Network\]](#)
[\[AppleTalk Cable\]](#)

[\[Home\]](#)
[\[Site Map\]](#)
[\[Logout\]](#)
[\[Save\]](#)
[\[Frame Enable\]](#)
[\[Disable\]](#)
[\[TELNET\]](#)

- Enter the VLAN ID that will contain the IP sub-net VLAN in the VLAN ID field.
- Enter a name for the VLAN in the Protocol_VLAN_Name field.
- Select the virtual interface from the Router_Interface pulldown list if you configured a virtual interface for routing into and out of the VLAN.
- Enter the IP address of the VLAN in the IP_Address field.
- Enter the network mask in the Mask field.
- Specify the port that are members for the VLAN:
 - Select Dynamic Port if you want the port membership to be dynamic. For information, see “Dynamic Ports” on page 13-9.
 - Click the Change Static Members button if you want to configure static ports. For information, see “Static Ports” on page 13-10.
 - Click the Change Exclude Members button if you want to explicitly exclude some ports. For information, see “Excluded Ports” on page 13-10.

NOTE: All the ports must be members of the port-based VLAN that contains this IP sub-net VLAN. See “Layer 3 Protocol-Based VLANs” on page 13-3.

11. Click the Add button (if you are adding a new VLAN) or the Modify button (if you are modifying an existing VLAN) to save the change to the device’s running-config file.
12. Select the [Save](#) link at the bottom of the dialog. Select Yes when prompted to save the configuration change to the startup-config file on the device’s flash memory.

NOTE: You also can access the dialog for saving configuration changes by clicking on Command in the tree view, then clicking on [Save to Flash](#).

Configuring an IPX Network VLAN

1. Log on to the device using a valid user name and password for read-write access.
2. Click on the plus sign next to Configure in the tree view to expand the list of configuration options.
3. Click on the plus sign next to VLAN in the tree view to expand the list of VLAN option links.
4. Click on the [Protocol](#) link.
 - If the device does not have any protocol VLANs, the Protocol VLAN configuration panel is displayed, as shown in the following example.
 - If at least one protocol VLAN is already configured and you are adding a new one, click on the [IPX Network](#) link to display the IP Sub-net Protocol VLAN configuration panel.
 - If you are modifying an existing protocol VLAN, click on the Modify button to the right of the row describing the VLAN to display the configuration panel for the type of VLAN you are modifying. The following example shows the IPX Network Protocol VLAN configuration dialog, used for configuring an IPX network protocol VLAN (not a protocol, IP sub-net, or AppleTalk cable VLAN)

VLAN Id:	<input type="text" value="1"/>
VLAN Port_members:	1/7,1/8, 3/1,3/2,3/3,3/4,3/5,3/6,3/7,3/8, 3/9,3/10,3/11,3/12,3/13,3/14 3/15,3/16, 3/17,3/18,3/19,3/20,3/21,3/22,3/23,3/24, 4/1,4/2,4/3,4/4,4/5,4/6 4/7,4/8, 4/9,4/10,4/11,4/12,4/13,4/14,4/15,4/16, 4/17,4/18,4/19,4/20,4/21,4/22 4/23,4/24
Protocol_VLAN_Name:	<input type="text"/>
Router Interface:	None <input type="button" value="v"/>
Frame_Type:	Ethernet_802.2 <input type="button" value="v"/>
Network:	<input type="text" value="00000200"/>
Selected Port Members:	<input type="checkbox"/> Dynamic Port Static Port: <input type="button" value="Change Static Members"/> Exclude Port: <input type="button" value="Change Exclude Members"/>

[\[Show\]](#)[\[Protocol\]](#)[\[IP Subnet\]](#)[\[IPX Network\]](#)[\[AppleTalk Cable\]](#)

[\[Home\]](#)[\[Site Map\]](#)[\[Logout\]](#)[\[Save\]](#)[\[Frame Enable\]](#)[\[Disable\]](#)[\[TELNET\]](#)

5. Enter the VLAN ID that will contain the IPX network VLAN in the VLAN ID field.
6. Enter a name for the VLAN in the Protocol_VLAN_Name field.

7. Select the virtual interface from the Router_Interface pulldown list if you configured a virtual interface for routing into and out of the VLAN.
8. Select the encapsulation type from the Frame_Type field's pulldown list.
9. Enter the IPX network address of the VLAN in the Network field.
10. Specify the port that are members for the VLAN:
 - Select Dynamic Port if you want the port membership to be dynamic. For information, see "Dynamic Ports" on page 13-9.
 - Click the Change Static Members button if you want to configure static ports. For information, see "Static Ports" on page 13-10.
 - Click the Change Exclude Members button if you want to explicitly exclude some ports. For information, see "Excluded Ports" on page 13-10.

NOTE: All the ports must be members of the port-based VLAN that contains this IPX network VLAN. See "Layer 3 Protocol-Based VLANs" on page 13-3.

11. Click the Add button (if you are adding a new VLAN) or the Modify button (if you are modifying an existing VLAN) to save the change to the device's running-config file.
12. Select the [Save](#) link at the bottom of the dialog. Select Yes when prompted to save the configuration change to the startup-config file on the device's flash memory.

NOTE: You also can access the dialog for saving configuration changes by clicking on Command in the tree view, then clicking on [Save to Flash](#).

Configuring an AppleTalk Cable VLAN

1. Log on to the device using a valid user name and password for read-write access.
2. Click on the plus sign next to Configure in the tree view to expand the list of configuration options.
3. Click on the plus sign next to VLAN in the tree view to expand the list of VLAN option links.
4. Click on the [Protocol](#) link.
 - If the device does not have any protocol VLANs, the Protocol VLAN configuration panel is displayed, as shown in the following example.
 - If at least one protocol VLAN is already configured and you are adding a new one, click on the [AppleTalk Cable](#) link to display the AppleTalk Cable VLAN configuration panel.
 - If you are modifying an existing protocol VLAN, click on the Modify button to the right of the row describing the VLAN to display the configuration panel for the type of VLAN you are modifying. The following example shows the AppleTalk Cable VLAN configuration dialog, used for configuring an AppleTalk cable VLAN (not a protocol, IP sub-net, or IPX network VLAN).

VLAN Id:	<input type="text" value="1"/>
VLAN Port_members:	1/7,1/8, 3/1,3/2,3/3,3/4, 3/5,3/6,3/7,3/8, 3/9,3/10,3/11,3/12,3/13,3/14 3/15,3/16, 3/17,3/18,3/19,3/20,3/21,3/22,3/23,3/24, 4/1,4/2,4/3,4/4,4/5,4/6 4/7,4/8, 4/9,4/10,4/11,4/12,4/13,4/14,4/15,4/16, 4/17,4/18,4/19,4/20,4/21,4/22 4/23,4/24
Protocol_VLAN_Name:	<input type="text"/>
Router_Interface:	None ▾
AppleTalk Cable:	1 ▾
Selected Port Members:	<input type="checkbox"/> Dynamic Port Static Port: <input type="button" value="Change Static Members"/> Exclude Port: <input type="button" value="Change Exclude Members"/>

[\[Show\]](#)[\[Protocol\]](#)[\[IP Subnet\]](#)[\[IPX Network\]](#)[\[AppleTalk Cable\]](#)

[\[Home\]](#)[\[Site Map\]](#)[\[Logout\]](#)[\[Save\]](#)[\[Frame Enable\]](#)[\[Disable\]](#)[\[TELNET\]](#)

5. Enter the VLAN ID that will contain the IPX network VLAN in the VLAN ID field.
6. Enter a name for the VLAN in the Protocol_VLAN_Name field.
7. Select the virtual interface from the Router_Interface pulldown list if you configured a virtual interface for routing into and out of the VLAN.
8. Select the AppleTalk cable ID from the AppleTalk Cable field's pulldown list.
9. Specify the port that are members for the VLAN:
 - Select Dynamic Port if you want the port membership to be dynamic. For information, see “Dynamic Ports” on page 13-9.
 - Click the Change Static Members button if you want to configure static ports. For information, see “Static Ports” on page 13-10.
 - Click the Change Exclude Members button if you want to explicitly exclude some ports. For information, see “Excluded Ports” on page 13-10.

NOTE: All the ports must be members of the port-based VLAN that contains this AppleTalk cable VLAN. See “Layer 3 Protocol-Based VLANs” on page 13-3.

10. Click the Add button (if you are adding a new VLAN) or the Modify button (if you are modifying an existing VLAN) to save the change to the device's running-config file.
11. Select the [Save](#) link at the bottom of the dialog. Select Yes when prompted to save the configuration change to the startup-config file on the device's flash memory.

NOTE: You also can access the dialog for saving configuration changes by clicking on Command in the tree view, then clicking on [Save to Flash](#).

Displaying VLAN Information

After you configure the VLANs, you can verify the configuration using the following methods.

Displaying System-Wide VLAN Information

Use one of the following methods to display VLAN information for all the VLANs configured on the device.

USING THE CLI

Enter the following command at any CLI level. This example shows the display for the IP sub-net and IPX network VLANs configured in the examples in “Configuring an IP Sub-Net VLAN with Dynamic Ports” on page 13-33 and “Configuring an IPX Network VLAN with Dynamic Ports” on page 13-34.

```
HP9300(config)# show vlans

Total PORT-VLAN entries: 2
Maximum PORT-VLAN entries: 8
legend: [S=Slot]

PORT-VLAN 1, Name DEFAULT-VLAN, Priority level0, Spanning tree Off
  Untagged Ports: (S2) 1 2 3 4 5 6 7 8 9 10 11 12 13 14 15 16
  Untagged Ports: (S2) 17 18 19 20 21 22 23 24
  Untagged Ports: (S4) 1 2 3 4 5 6 7 8 9 10 11 12 13 14 15 16
  Untagged Ports: (S4) 17 18 19 20 21 22 23 24
  Tagged Ports: None

PORT-VLAN 10, Name IP_VLAN, Priority level0, Spanning tree Off
  Untagged Ports: (S1) 1 2 3 4 5 6
  Tagged Ports: None

IP-subnet VLAN 1.1.1.0 255.255.255.0, Dynamic port enabled
  Name: Mktg-LAN
  Static ports: None
  Exclude ports: None
  Dynamic ports: (S1) 1 2 3 4 5 6
PORT-VLAN 20, Name IPX_VLAN, Priority level0, Spanning tree Off
  Untagged Ports: (S2) 1 2 3 4 5 6
  Tagged Ports: None

IPX-network VLAN 0000ABCD, frame type ethernet_ii, Dynamic port enabled
  Name: Eng-LAN
  Static ports: None
  Exclude ports: None
  Dynamic ports: (S2) 1 2 3 4 5 6
```

Syntax: show vlans [*<vlan-id>* | ethernet *<portnum>*]

USING THE WEB MANAGEMENT INTERFACE

To display VLAN configuration information:

1. Log on to the device using a valid user name and password for read-only or read-write access. The System configuration dialog is displayed.
2. Click on the plus sign next to Configure in the tree view to expand the list of configuration options.
3. Click on the plus sign next to VLAN in the tree view to expand the list of VLAN option links.
4. Click on the [Port](#) link to display the Port-based VLAN table or the [Protocol](#) link to display the Protocol-based VLAN table.

Displaying VLAN Information for Specific Ports

Use one of the following methods to display VLAN information for specific ports.

USING THE CLI

To display VLAN information for all the VLANs of which port 7/1 is a member, enter the following command:

```
HP9300(config)# show vlans e 7/1
```

```
Total PORT-VLAN entries: 3
```

```
Maximum PORT-VLAN entries: 8
```

```
legend: [S=Slot]
```

```
PORT-VLAN 100, Name [None], Priority level0, Spanning tree Off
```

```
Untagged Ports: (S7) 1 2 3 4
```

```
Tagged Ports: None
```

```
IP-subnet VLAN 207.95.11.0 255.255.255.0, Dynamic port disabled
```

```
Static ports: (S7) 1 2
```

```
Exclude ports: None
```

```
Dynamic ports: None
```

Syntax: show vlans [<vlan-id> | ethernet <portnum>]

The <vlan-id> parameter specifies a VLAN for which you want to display the configuration information.

The **ethernet** <portnum> parameter specifies a port.

USING THE WEB MANAGEMENT INTERFACE

You cannot display port-specific VLAN information using the Web management interface.