

HP 100VG Recessed Transceivers Installation Guide

Introduction

The HP 100VG Recessed Transceivers are used to provide connection to various network media for the HP J2981A 100VG Module and other HP networking devices that are designed to accept these transceivers. The transceivers are installed into the 100VG Xcvr Slot of the HP networking device or device module.

This document describes how to install, verify, and troubleshoot the following three transceivers:

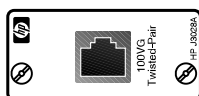

HP J3028A Recessed 100VG Twisted-Pair Transceiver

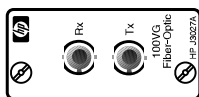

HP J3027A Recessed 100VG Fiber-Optic Multimode ST Transceiver

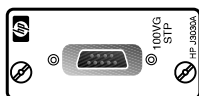

HP J3030A Recessed 100VG Shielded Twisted-Pair Transceiver

Note:

The illustrations in this document show the above listed units being used with the HP J2981A 100VG Module. The procedures described in this document also pertain to using these units in other HP networking devices that are designed to accept them.

Installation Steps

Warning: Turn off power to the device that will accept the transceiver.

The steps to install the HP 100VG Recessed Transceivers are:

1. Insert the transceiver into an HP networking device's 100VG Xcvr slot.
2. Connect the network cables to the transceiver.
3. Apply power to the HP networking device or device module into which the transceiver is installed, and check the transceiver for correct operation.

Details on these steps are provided in the rest of this document.

1. Insert the transceiver into the slot.

The transceivers are installed into an HP networking device in an identical manner, as follows:

1. Remove AC power from the HP networking device or device module; then, using a flat-bladed or Torx T-10 screwdriver, unscrew the two retaining screws on the existing transceiver, or 100VG Xcvr cover plate, and remove it from the HP networking device or device module.

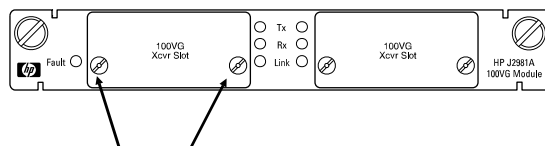

Loosen the captured screws on a 100VG Xcvr cover plate.

2. Touch a grounded, metal object (such as a powered on hub) to discharge any static electricity on your body, then carefully remove the transceiver from its protective anti-static packaging. Hold the transceiver by its edges, taking care not touch any of its metal connectors.
3. Slide the transceiver firmly into the 100VG Xcvr slot as far as it will go. The transceiver's faceplate should touch the face of the device. The following illustration shows two twisted-pair transceivers sliding into an HP 100VG Module.

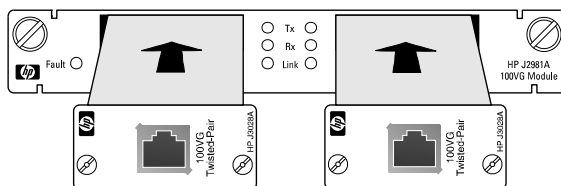

4. Using the flat-bladed or Torx T-10 screwdriver, tighten the spring-loaded retaining screws on the transceiver until they are snug. *Be careful that you do not overtighten the screws.*

2. Connect network cables to the transceiver or port.

The cabling instructions for each transceiver are different and are described in the specific section of this guide for that device. For cabling details, find the section that corresponds to your transceiver.

HP J3028A Recessed 100VG Twisted-Pair Transceiver

The HP J3028A Recessed 100VG Twisted-Pair Transceiver connects an HP networking device to an unshielded twisted-pair (UTP) network. This transceiver is compatible with IEEE 802.12 standard.

Connecting the Twisted-Pair Cable

An HP 100VG LAN supports category 3, 4, and 5 four-pair, 100 ohm UTP (unshielded twisted-pair) cables. Category 3 UTP cable is standard, voice-grade, telephone cable. If you have a twisted-pair cable that complies with Ethernet/IEEE 802.3 Type 10Base-T specifications and it is four-pair, you can use the same cable for this transceiver.

For category 3 and 4, the maximum cable length is 100 meters. For category 5, you can connect up to 200 meters of cable.

Push the cable's 8-pin RJ-45 plug into the transceiver's jack until it clicks into place.

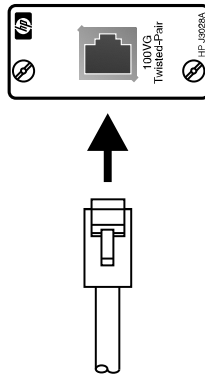

When power has been supplied to the HP networking device or device module into which the transceiver is installed, check the Link or port LED that pertains to the transceiver on the device. If the transceiver is receiving a signal properly, the Link or port LED should be ON. If the Link or port LED is OFF, see Troubleshooting on page 6.

HP J3027A Recessed Fiber-Optic Multimode ST Transceiver

The HP J3027A Recessed Fiber-Optic Multimode ST Transceiver connects an HP networking device to a fiber-optic network. This transceiver is compatible with the IEEE 802.12 and its wavelength is 1300nm. Optical fibers conforming to the ISO/IEC DIS 11801 standard will work with this transceiver.

Connecting the Fiber-Optic Cable

Important: Fiber-optic cables have two separate fibers for delivery of data to and from the transceiver. The two fibers are identical, but there are several different conventions to enable you to tell the fibers apart. For example, on some fiber-optic cables, only one of the fibers has lettering imprinted on its insulating sheath. *Make sure that the fiber that is connected to the transceiver's transmit (Tx) port is connected to the receive (Rx) port on the device at the other end of the cable, and vice versa.*

To connect a fiber-optic cable to a transceiver:

1. Remove the plastic dust covers from the cable connectors and the transceiver jacks.
2. Match the “key” on the connector of one of the fibers to the slot in the transceiver’s jack. See the illustration.
3. Press and twist the connector onto the jack so that the pins on the jack slide into the diagonal slots on the connector and the connector snaps securely into place.
4. Repeat steps 1 and 2 for the other fiber, connecting it to the other jack on the transceiver.
5. When power is applied to this transceiver in its module, the Link or port LED should be ON. If the LED is off, see Troubleshooting on page 6.

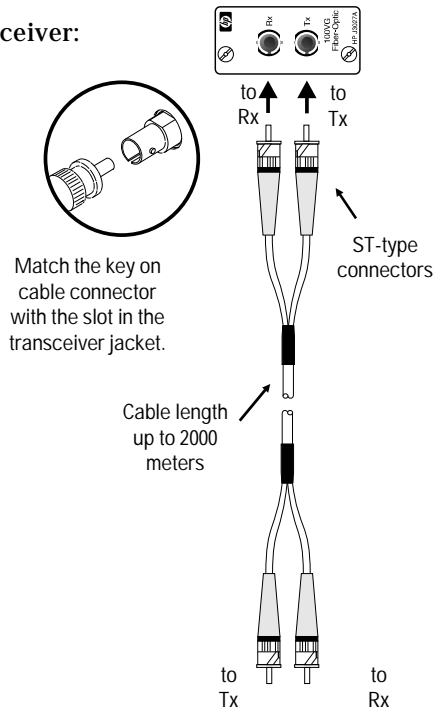

HP J3030A Recessed 100VG Shielded Twisted-Pair Transceiver

The HP J3030A Recessed 100VG Twisted-Pair Transceiver connects an HP networking device to a shielded twisted-pair (STP) network. This transceiver is compatible with IEEE 802.12.

Connecting the Shielded Twisted-Pair Cable

An HP 100VG LAN supports cable type 1 and 2 of shielded twisted-pair cable. Maximum cable length is 100 meters.

Push the shielded twisted-pair cable into the transceiver. This cable must conform to ISO/IEC DIS 11801 premise wiring standard. If there are screws on the connector tighten the screws.

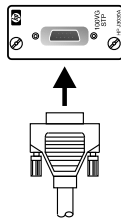

When power has been supplied to the HP networking device or device module into which the transceiver is installed, the port or Link LED should be ON. If the port or Link LED is off, see Troubleshooting below.

Troubleshooting

The following problems may exist:

- The connections to the transceiver are broken or faulty. Check all cabling and connections (including patch panels).
- A connected device is not transmitting the signal. The device must be a 100VG device such as a HP 10/100VG PCI LAN Adapter.

Use the device's console interface (for example VT-100 console, HP Stack Manager or HP Interconnect Manager) to enable the 100VG Xcvr port. See the HP networking device's manual (such as the *HPJ2980A 10/100 Switch-16 Installation and Reference Guide*) for more information.

Specifications

Physical

Dimensions All Transceivers

Width	4.14 cm (1.63 in)
Depth	9.22 cm (3.63 in)
Height	2.36 cm (.93 in)
Weight	50 g

Environmental

Operating temperature:	0°C to 55°C (32°F to 131°F)
Nonoperating temperature:	-40°C to 70°C (-40°F to 158°F)
Relative humidity:	15% to 95% at 40°C (104°F) non-condensing
Maximum altitude:	4.6 km(15,000 feet)

Electromagnetic

- Emissions**
- FCC part 15 Class A
- EN55022 / CISPR-22 Class A
- VCCI Level 1

Immunity

See the Declaration of Conformity in the module documentation that accepts these transceivers (e.g., *HP J2981A AdvanceStack 100VG Module Installation and Reference Guide*).

Complies with Canadian EMC Class A requirements.

Technical information in this document is subject to change without notice.

All rights reserved. Reproduction, adaptation, or translation without prior written permission is prohibited except as allowed under the copyright laws.

© 1995 Hewlett-Packard Company
HP Part Number: 5963-6533
Edition 1, November 1995
Printed in U.S.A.

